

CATÁLOGO DE PRODUCTOS



Láminas



Barras

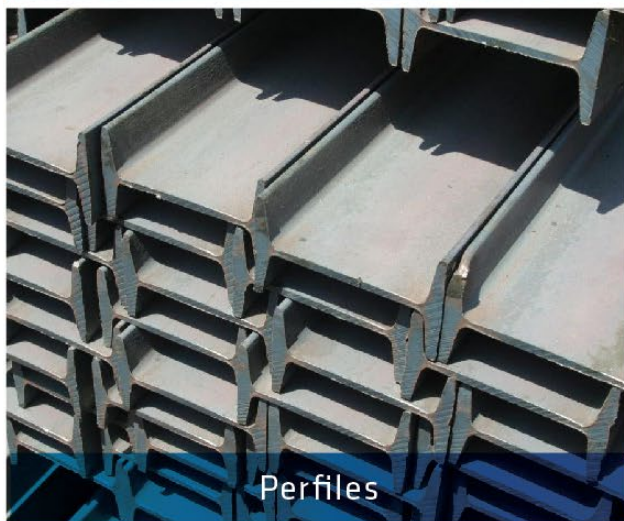

Perfiles

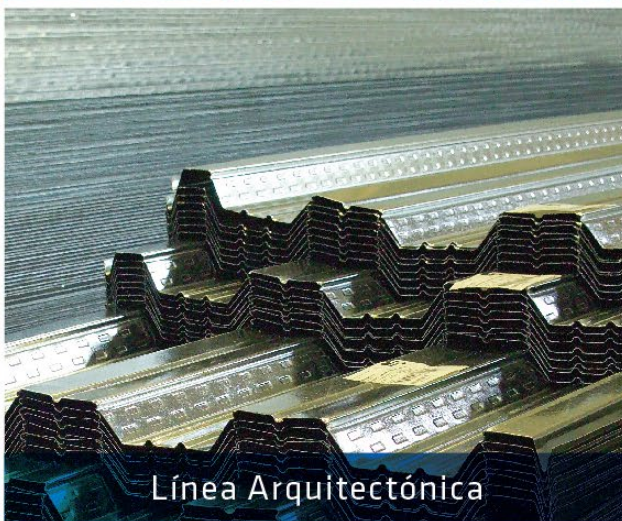

Línea Arquitectónica



Tuberías

STECKERL ACEROS

TRIPLE-S STEEL



CATÁLOGO DE PRODUCTOS

TERCERA EDICIÓN 2015

LÁMINAS • BARRAS • PERFILES • TUBERÍA • LÍNEA ARQUITECTÓNICA

www.steckerlacers.com

Esta prohibida su publicación o reproducción integral o parcial, sin la autorización escrita de quien las pronunció. Ley No. 23 de 1982.

1

LÁMINAS DE ACERO CARBÓN

9

1.0	DIMENSIONES, TOLERANCIAS Y DESVIACIONES PARA LÁMINAS TERMINADAS EN CALIENTE	10
1.1	CALIDADES DE ACEROS PLANOS MÁS COMERCIALES EN COLOMBIA	11
1.2	LÁMINAS HOT ROLLED Ó LAMINADAS EN CALIENTE (DIMENSIONES Y PESOS)	12
1.3	LÁMINAS ALFAJOR O ANTIDESLIZANTE (DIMENSIONES Y PESOS)	13
1.4	LÁMINAS COLD ROLLED O LAMINADOS EN FRIO (DIMENSIONES Y PESOS)	14
1.5	LÁMINAS GALVANIZADAS (DIMENSIONES Y PESOS)	15
1.6	RESUMEN DE LÁMINAS MAS COMERCIALES	16

2

BARRAS DE ACERO

17

2.0	CALIDADES DE ACEROS LARGOS MÁS FRECUENTES EN COLOMBIA	18
2.1	BARRAS CORRUGADAS O BARRAS DE REFUERZO	19
2.2	VARILLAS LISAS Ó REDONDOS LISOS	20
2.3	PLATINAS Y CUADRADOS	21
2.4	GRAFILES Y MALLAS	22
2.5	MALLAS ELECTROSOLDADAS	23
2.5	MALLAS ELECTROSOLDADAS	24
2.6	ACERO FIGURADO	25
2.7	RESUMEN DE BARRAS MÁS COMERCIALES	26

3

PERFILES DE ACERO

27

	PERFIL TIPO EUROPEO EN 10025 - 1990	28
3.0	PERFIL TIPO EUROPEO - CALIDADES DE ACERO	29
3.1	EQUIVALENCIAS ENTRE NORMAS DE ACERO	30
3.2	TOLERANCIAS DE PERFILES ESTRUCTURALES: IPN, IPE, HE, HD, HP, UB, UC, W.	31
3.3	TOLERANCIAS DE PERFILES ESTRUCTURALES: U, UPN, UAP, C.	32
3.4	PERFILES EN L Ó ÁNGULOS DE LADOS IGUALES (MILIMÉTRICOS)	33
3.5	PERFILES EN U Ó C ESTÁNDAR EUROPEO - UPN Y PERFIL C SECCIÓN PEQUEÑA	34
3.6	PERFILES C DE ALAS PARALELAS UPE, ESPAÑA Y POLONIA	35
3.7	PERFIL I ESTÁNDAR EUROPEO - IPN	36
3.8	PERFIL I LIVIANO DE ALAS PARALELAS - IPE	37
3.8	PERFIL I LIVIANO DE ALAS PARALELAS - IPE	38
3.9	PERFIL H EUROPEO DE ALA ANCHA - HE	39
3.9	PERFIL H EUROPEO DE ALA ANCHA - HE	40
3.9	PERFIL H EUROPEO DE ALA ANCHA - HE	41
3.10	PERFIL H DE ALA ANCHA (COLUMNAS) HD	42
3.10	PERFIL H DE ALA ANCHA (COLUMNAS) HD	43
3.11	PERFIL H DE ALA EXTRA ANCHA - HL Y HX	44
3.12	PERFIL H DE ALA ANCHA (PILOTES) - HP	45
3.13	PERFILES TIPO AMERICANO - CALIDADES DE ACEROS Y TOLERANCIAS	46
3.14	ÁNGULO TIPO AMERICANO DE LADOS IGUALES	47
3.15	PERFIL U O C ESTÁNDAR AMERICANO	48
3.16	PERFIL I ESTÁNDAR AMERICANO - S	49
3.17	PERFIL H AMERICANO DE ALA ANCHA O WF	50
3.17	PERFIL H AMERICANO DE ALA ANCHA O WF	51
3.17	PERFIL H AMERICANO DE ALA ANCHA O WF	52
3.17	PERFIL H AMERICANO DE ALA ANCHA O WF	53

3.17	PERFIL H AMERICANO DE ALA ANCHA O WF	54
3.17	PERFIL H AMERICANO DE ALA ANCHA O WF	55
3.17	PERFIL H AMERICANO DE ALA ANCHA O WF	56
3.18	EQUIVALENCIAS ENTRE PERFILES EUROPEOS (IPE, HE, IPN, HD) Y AMERICANOS (WF Y S)	57
3.18	EQUIVALENCIAS ENTRE PERFILES EUROPEOS (IPE, HE, IPN, HD) Y AMERICANOS (WF Y S)	58
3.18	EQUIVALENCIAS ENTRE PERFILES EUROPEOS (IPE, HE, IPN, HD) Y AMERICANOS (WF Y S)	59
3.18	EQUIVALENCIAS ENTRE PERFILES EUROPEOS (IPE, HE, IPN, HD) Y AMERICANOS (WF Y S)	60
3.18	EQUIVALENCIAS ENTRE PERFILES EUROPEOS (IPE, HE, IPN, HD) Y AMERICANOS (WF Y S)	61
3.19	RESUMEN DE PERFILES MÁS COMERCIALES	62

TUBERÍA EN ACERO CARBÓN

63

4.0	TUBERÍA DE ACERO CARBÓN PARA CONDUCCIÓN	64
4.0	TUBERÍA DE ACERO CARBÓN PARA CONDUCCIÓN	65
4.1	TUBERÍA DE ACERO ESTRUCTURAL REDONDA	66
4.2	TUBERÍA DE ACERO ESTRUCTURAL CUADRADA	67
4.3	TUBERÍA DE ACERO ESTRUCTURAL RECTANGULAR	68
4.4	TUBERÍA DE ACERO NEGRA Y GALVANIZADA - CERRAMIENTO	69
4.5	TUBERÍA DE ACERO PARA FABRICACIÓN DE MUEBLES - REDONDOS	70
4.6	TUBERÍA DE ACERO PARA FABRICACIÓN DE MUEBLES - CUADRADOS, RECTANGULARES Y OVALADOS	71
4.6	TUBERÍA DE ACERO PARA FABRICACIÓN DE MUEBLES - CUADRADOS, RECTANGULARES Y OVALADOS	72
4.7	RESUMEN	73
4.7	RESUMEN	74

LÍNEA ARQUITECTÓNICA

75

5.0	STEEL DECK 2.0"	76
5.0	STEEL DECK 2.0"	77
5.1	STEEL DECK 3.0"	78
5.1	STEEL DECK 3.0"	79
5.2	PERFIL EN C NEGRO	80
5.3	PERFIL EN C GALVANIZADO	81
5.4	PERFIL EN Z NEGRO Y GALVANIZADO	82
5.5	PERFIL ESTRUCTURAL C CAJÓN NEGRO	83
5.6	PERFIL ESTRUCTURAL C CAJÓN GALVANIZADO	84
5.7	PERFIL ESTRUCTURAL I NEGRO	85
5.8	PERFIL ESTRUCTURAL I GALVANIZADO	86
5.9	CUBIERTA TRAPEZOIDAL	87
5.10	CUBIERTA TRAPEZOIDAL TIPO CANALETA	88
5.11	CUBIERTA METÁLICA	89
5.12	TEJA SIN TRASLAPO	90
5.12	TEJA SIN TRASLAPO	91
5.13	RESUMEN	92
5.13	RESUMEN	93



Para Steckerl Aceros S A S., es motivo de satisfacción poner en sus manos, la más reciente versión de nuestro catálogo de productos. Por ello, hemos actualizado su diseño, enfocándonos en la utilidad para todas aquellas personas que deseen tener este texto como medio de consulta.

Organizamos nuestro catalogo en cinco grandes capítulos, diferenciándolo con rótulos y ordenándolo en la misma secuencia lógica que nos sugiere nuestro arancel de aduanas, para hacer más fácil su lectura.

En el primer capítulo Láminas de Acero, laminadas tanto en frío como en caliente, seleccionamos las calidades de uso más frecuente en Colombia, según ASME, ASTM, NTC y Norma Europea EN: ASTM A-36, A-572 GR 50, A-588 GR B, A-131 GR A, ASME SA-283 GR C, SA-516 GR 70, porque en base a su composición química y propiedades mecánicas, se puede construir desde una gran embarcación marítima hasta la estructura más simple.

En el segundo capítulo Barras de Aceros ó Productos largos, enfatizamos los utilizados principalmente en trabajos de ornamentación, estructuras metálicas, fabricación de pernos de anclaje, conectores y tensores, etc.

En el tercer capítulo Perfiles de Acero, en L, C, H e I, elegimos las fichas técnicas de las referencias fabricadas bajo norma Europea, preferidas en Colombia y Americana únicamente, señalando las tolerancias que esas normas permiten para cada referencia de perfil y un cuadro de equivalencias entre perfiles americanos y europeos, aspectos diferenciadores de los catálogos anteriores. Colombia en cuanto a vigas es METRICA y por lo tanto el mercado cuenta con una mayor disponibilidad de perfiles europeos tipo IPE - HEA - HEB.

En Steckerl Aceros contamos desde nuestra casa matriz en Estados Unidos con el mayor surtido de perfiles americanos que atendemos contra pedido en plazos muy cortos.

En el cuarto capítulo Tubería de Acero, destacamos la tubería estructural con sus diferentes presentaciones: cuadrada, redonda y rectangular la cual ha tenido un crecimiento muy importante en el mercado nacional; incluimos tubos de conducción y ornamentación que hacen parte de nuestra línea de ventas.

En el quinto capítulo Línea Arquitectónica, hemos agrupado los productos que se forman en frío, fabricados a partir de láminas de acero, con o sin, recubrimiento y que son usados en la construcción de estructuras como: perlines, losas colaborantes y cubiertas.

Nuestro interés principal es promover el diseño y uso del acero y de la estructura metálica en Colombia, por ser una alternativa válida, económica y rápida de construcción. Asimismo, entregar las fichas técnicas de cada producto y hacer un compendio de los elementos de acero de uso estructural comercializados habitualmente, lo cual está plasmado al final de cada capítulo. Lo anterior, con el objetivo de ofrecer a los ingenieros calculistas la posibilidad de seleccionar entre esos elementos, los requeridos para su diseño y de esta manera tener la certeza que cuando su proyecto esté en marcha no sufrirá retrasos por falta de suministro.

Finalmente, expresarles que el esfuerzo invertido en el diseño y edición de este trabajo, se vea reflejado en un servicio más especializado por parte de nuestra fuerza de ventas, en busca de optimizar las relaciones comerciales con nuestros clientes, así como en la promoción de la construcción de estructura metálica en Colombia.

A close-up photograph of a stack of carbon steel sheets. The sheets are dark grey and stacked neatly, showing the edges of many layers. A large, white, bold number '1' is overlaid on the top surface of the stack. The background is blurred, showing more of the stack and some green and brown tones.

1

**LÁMINAS DE
ACERO CARBÓN**

1

1.0 DIMENSIONES, TOLERANCIAS Y DESVIACIONES PARA LÁMINAS TERMINADAS EN CALIENTE

Tolerancias estándar en espesor para láminas terminadas en caliente (únicamente acero al carbono y estructural), medidas a una distancia mínima al borde de 3/8 de pulgada (borde cortado) y a 3/4 de pulgada (borde laminado) (Rollos y láminas cortadas, incluyendo decapadas)

ANCHO ESPECIFICADO, PULGADA	TOLERANCIA DE ESPESOR POR ENCIMA, PULGADAS, NO EXISTE TOLERANCIA POR DEBAJO B					
	ESPESOR ESPECIFICADO EN LA ORDEN, PULGADAS A					
	De 0,027 a 0,051 inclusive	Más de 0,051 a 0,057 inclusive	Más de 0,057 a 0,071 inclusive	Más de 0,071 a 0,098 inclusive	Más de 0,098 a 0,180 excluido	De 0,180 a 0,230 excluido
De 12 a 20 inclusive	0,010	0,010	0,012	0,012	0,014	0,014
Más de 20 a 40 inclusive	0,010	0,010	0,012	0,014	0,014	0,016
Más de 40 a 48 inclusive	0,010	0,012	0,012	0,014	0,016	0,018
Más de 48 a 60 inclusive	... C	0,012	0,014	0,014	0,016	0,020
Más de 60 a 72 inclusive	... C	0,014	0,014	0,016	0,016	0,022
Más de 72	... C	... C	... C	0,016	0,016	0,024
A	El rango de espesor especificado en los encabezados se aplica independiente de cómo se haya establecido el espesor en la orden como normal o mínimo.					
B	Las tolerancias dadas en la tabla están basadas sobre el espesor mínimo (tolerancia por encima, no tolerancia por debajo). Para espesor nominal la tolerancia se divide por igual por encima y por debajo.					
C	En donde aparecen puntos suspensivos en la tabla los requisitos no han sido definidos.					
NOTA 1	El espesor se mide en cualquier punto del ancho mínimo a 3/8 de pulgadas en láminas de borde costado y mínimo a 3/4 en láminas de borde laminado. Esta tabla no se aplica para los extremos o finales de corte de los rollos de borde laminado.					
NOTA 2	Los micrómetros usados para la medición del espesor deben estar equipados con topes y vástagos cuyos diámetros mínimos son de 4.80 mm (0,188 pulgadas). La punta del vástago debe ser plana y la punta del tope debe ser plana o redondeada con un radio mínimo de curvatura de 2,55 (0,10 pulgadas). Los micrómetros con puntas afiladas no son adecuadas para las mediciones de espesor.					

Tolerancias restringidas en espesor para láminas terminadas en caliente (únicamente acero al carbono y estructural), medidas a una distancia mínima al borde de 5/8 de pulgada (borde cortado) y a 1 de pulgada (borde laminado) (Rollos y láminas cortadas, incluyendo decapadas)

ANCHO ESPECIFICADO, PULGADA	TOLERANCIA DE ESPESOR POR ENCIMA, PULGADAS, NO EXISTE TOLERANCIA POR DEBAJO B					
	ESPESOR ESPECIFICADO EN LA ORDEN, PULGADAS A					
	De 0,027 a 0,051 inclusive	Más de 0,051 a 0,057 inclusive	Más de 0,057 a 0,071 inclusive	Más de 0,071 a 0,098 inclusive	Más de 0,098 a 0,180 excluido	De 0,180 a 0,230 excluido
De 12 a 20 inclusive	0,008	0,008	0,009	0,009	0,010	0,010
Más de 20 a 40 inclusive	0,008	0,008	0,009	0,010	0,010	0,012
Más de 40 a 48 inclusive	0,008	0,009	0,009	0,010	0,012	0,014
Más de 48 a 60 inclusive	... C	0,009	0,010	0,010	0,012	0,015
Más de 60 a 72 inclusive	... C	0,010	0,010	0,012	0,012	0,016
Más de 72	... C	... C	... C	0,012	0,012	0,016
A	El rango de espesor especificado en los encabezados se aplica independiente de cómo se haya establecido el espesor en la orden como normal o mínimo.					
B	Las tolerancias dadas en la tabla están basadas sobre el espesor mínimo (tolerancia por encima, no tolerancia por debajo). Para espesor nominal la tolerancia se divide por igual por encima y por debajo.					
C	En donde aparecen puntos suspensivos en la tabla los requisitos no han sido definidos.					
NOTA 1	El espesor se mide en cualquier punto del ancho mínimo a 3/8 de pulgadas en láminas de borde costado y mínimo a 3/4 en láminas de borde laminado. Esta tabla no se aplica para los extremos o finales de corte de los rollos de borde laminado.					
NOTA 2	Los micrómetros usados para la medición del espesor deben estar equipados con topes y vástagos cuyos diámetros mínimos son de 4.80 mm (0,188 pulgadas). La punta del vástago debe ser plana y la punta del tope debe ser plana o redondeada con un radio mínimo de curvatura de 2,55 (0,10 pulgadas). Los micrómetros con puntas afiladas no son adecuadas para las mediciones de espesor.					
NOTA 3	Esta tabla se construyó multiplicando los valores de la tabla estándar por 0,75 y redondeándolos a valores con tres cifras decimales, empleando la norma ASTM.					

1

1.1 CALIDADES DE ACEROS PLANOS MÁS COMERCIALES EN COLOMBIA

CALIDADES MAS COMUNES		COMPOSICIÓN QUÍMICA										PROPIEDADES MECÁNICAS			APLICACIONES MAS FRECUENTES
ASTM	DIN	L	C	MN	P	S	SI	CU	Ni	Cr	V	LÍMITE ELÁSTICO	RESISTENCIA A LA TRACCIÓN	% ALARGA	
A - 36	ST 33 - 1.2	MIN		80			15						400MPa	20	Estructuras metálicas en general.
	ST 37 - 3U	MAX	25	120	4	4	30					≥250MPa	550MPa	23	
A - 283 GR C	RST 37 - 1.2	MIN		50			7					-	380MPa	20	Tanques de almacenamiento
		MAX	18	90	3.5	3.5	35					205MPa	450MPa	23	
A - 285 GR C	HII	MIN										-	380MPa	23	Recipientes a presión de baja e intermedia resistencia a la tracción.
		MAX	28	90	3.5	3.5						205MPa	515MPa	27	
A - 131 GR A	RST 34 - 1.2	MIN		53				20				-	400MPa	21	Construcción naval en general.
		MAX	21		4	4	50.4	20				235MPa	490MPa	24	
A - 516 GR 70	17mn4	MIN	27	85			15					-	485MPa	17	Recipientes a presión temperaturas media- alta.
		MAX	31	120	4	3.5	40					260MPa	620MPa	21	
A - 514 GR A	RQT 601	MIN				1.5						-	690MPa	-	Resistencia a la abrasion.
		MAX	20	150	3.5	4	50					≥600MPa	850MPa	19	
A - 572 GR 50	ST 52-3N	MIN					15							-	Fabricación de estructuras metálicas.
		MAX	23	135	4	5	40					≥345MPa	450MPa	20	
A - 588 GR B	WTST 52-3	MIN		75			15	2		4	0.1	-		-	Fabricación de estructuras metálicas que no requerirán de recubrimiento.
		MAX	20	135	4	5	40	4	5	7	1	345MPa	485MPa	18	

FORMATOS DE LÁMINAS MÁS COMERCIALES EN COLOMBIA

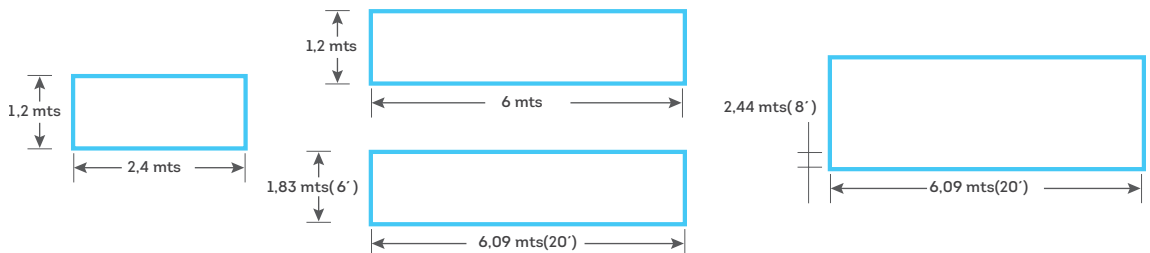

1

1.2 LÁMINAS HOT ROLLED Ó LAMINADAS EN CALIENTE (DIMENSIONES Y PESOS)

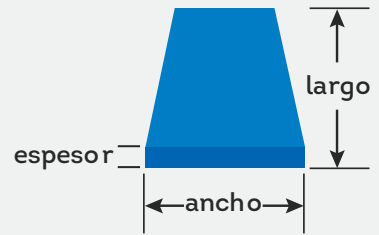

DIMENSIONES Y PESOS DE PLANCHAS COMERCIALES

	ESPESOR		M2	1.0 X 2.0 M	1.22 X 2.44 M (4' X 8')	1.83 X 6.09 M (6' X 20')	2.0 X 6.0 M	2.44 X 6.09 M (8' X 20')	
	CALIBRE	PULGADA	MILÍMETRO	Kg.	Kg.	Kg.	Kg.	Kg.	
LÁMINAS EN CALIENTE	16		1.50	11.78	23.56	35.01	131.00	141.00	175.00
	14		1.90	14.92	29.85	44.35	166.00	179.00	222.00
			2.50	19.63	39.27	58.35	219.00	236.00	292.00
	12		2.66	20.89	41.78	62.09	233.00	251.00	311.00
	11		3.00	23.56	47.12	70.02	263.00	283.00	350.00
		1/8"	3.17	24.90	49.79	73.99	278.00	299.00	370.00
			4.00	31.42	62.83	93.37	350.00	377.00	467.00
			4.50	35.34	70.69	105.04	394.00	424.00	525.00
		3/16"	4.76	37.38	74.77	111.11	417.00	449.00	556.00
			5.00	39.27	78.54	116.71	438.00	471.00	584.00
			6.00	47.12	94.25	140.05	525.00	565.00	700.00
		1/4"	6.35	49.87	99.75	148.22	556.00	598.00	741.00
		5/16"	7.94	62.36	124.72	185.33	695.00	748.00	927.00
			8.00	62.83	125.66	186.73	700.00	754.00	934.00
			9.00	70.69	141.37	210.07	788.00	848.00	1.051.00
		3/8"	9.53	74.85	149.70	222.44	834.00	898.00	1.113.00
			10.00	78.54	157.08	233.41	876.00	942.00	1.167.00
			12.00	94.25	188.50	280.10	1.051.00	1.131.00	1.401.00
		1/2"	12.70	99.75	199.49	296.44	1.112.00	1.197.00	1.483.00
			13.00	102.10	204.20	303.44	1.138.00	1.225.00	1.518.00
			15.00	117.81	235.62	350.12	1.313.00	1.414.00	1.751.00
		5/8"	15.88	124.72	249.44	370.66	1.390.00	1.497.00	1.854.00
			16.00	125.66	251.33	373.46	1.401.00	1.508.00	1.868.00
			19.00	149.23	298.45	443.49	1.664.00	1.791.00	2.218.00
		3/4"	19.05	149.62	299.24	444.65	1.668.00	1.795.00	2.224.00
			22.00	172.79	345.58	513.51	1.926.00	2.073.00	2.568.00
		7/8"	22.23	174.59	349.19	518.88	1.946.00	2.095.00	2.595.00
			25.00	196.35	392.70	583.54	2.189.00	2.356.00	2.919.00
		1"	25.40	199.49	398.98	592.87	2.224.00	2.394.00	2.965.00
			30.00	235.62	471.24	700.24	2.627.00	2.827.00	3.502.00
		1 1/4"	31.75	249.36	498.73	741.09	2.780.00	2.992.00	3.707.00
			32.00	251.33	502.65	746.93	2.802.00	3.016.00	3.736.00
			35.00	274.89	549.78	816.95	3.065.00	3.299.00	4.086.00
			38.00	298.45	596.90	886.97	3.327.00	3.581.00	4.436.00
		1 1/2"	38.10	299.24	598.47	889.31	3.336.00	3.591.00	4.448.00
			40.00	314.16	628.32	933.66	3.502.00	3.770.00	4.670.00
			50.00	392.70	785.40	1.167.07	4.378.00	4.712.00	5.837.00
		2"	50.80	398.98	797.96	1.185.74	4.448.00	4.788.00	5.931.00
			62.00	486.95	973.89	1.447.17	5.429.00	5.843.00	7.238.00
		2 1/2"	63.50	498.73	997.46	1.482.18	5.560.00	5.985.00	7.413.00
		75.00	589.05	1.178.10	1.750.61	6.567.00	7.069.00	8.756.00	
	3"	76.20	598.47	1.196.95	1.778.62	6.672.00	7.182.00	8.896.00	
		100.00	785.40	1.570.80	2.334.14	8.756.00	9.425.00	11.675.00	
	4"	101.60	797.96	1.595.93	2.371.49	8.896.00	9.576.00	11.861.00	

1

1.3 LÁMINAS ALFAJOR Ó ANTIDESLIZANTES

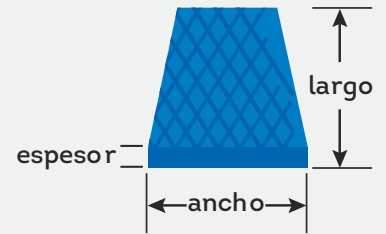

LÁMINAS ALFAJOR O ANTIDESLIZANTE								ESPECIFICACIONES TÉCNICAS					
CALIDADES MAS COMUNES		COMPOSICIÓN QUÍMICA						PROPIEDADES MECÁNICAS				APLICACIONES MAS FRECUENTES	
		L	C	MN	P	S	SI	CU	LIMITE ELÁSTICO	RESISTENCIA A LA TRACCIÓN	% ALARGA		
ASTM	DIN	(x 100)	(x 100)	(x 100)	(x 100)	(x 100)	(x 100)						Fabricación de pisos antideslizantes
ASTM 569	MIN												
	MAX	15	60	3,5	1			25Kg/mm3	250MPa	35KgI mm2	365MPa	22	

DIMENSIONES Y PESOS DE PLANCHAS COMERCIALES									
	ESPESOR		M2	1.0 X 2.0 MTS	1.22 X 2.44 M (4' X 8')	1.0 X 3.0 M	1.22 X 3.66 M (4' X 12')	1.83 X 6.09 M (6' X 20')	
	CALIBRE	PULGADA	MILIMETRO	Kg.	Kg.	Kg.	Kg.	Kg.	
LÁMINAS ALFAJOR			2.50	20.68	41.35	61.44	62.03	92.32	230.00
	12		2.66	22.00	44.00	65.38	65.99	98.23	245.00
	11		3.00	24.81	49.62	73.73	74.43	110.78	277.00
		1/8"	3.17	26.22	52.43	77.91	78.65	117.06	292.00
			4.00	33.08	66.16	98.31	99.24	147.71	369.00
			4.50	37.22	74.43	110.60	111.65	166.17	415.00
		3/16"	4.76	39.37	78.73	116.99	118.10	175.77	439.00
			5.00	41.35	82.70	122.89	124.05	184.64	461.00
			5.50	45.49	90.97	135.18	136.46	203.10	507.00
			6.00	49.62	99.24	147.47	148.86	221.56	553.00
		1/4"	6.35	52.51	105.03	156.07	157.54	234.49	585.00
			7.50	62.03	124.05	184.33	186.08	276.95	691.00
		5/16"	7.94	65.66	131.33	195.15	196.99	293.20	732.00
			8.00	66.16	132.32	196.62	198.48	295.42	738.00
			9.00	74.43	148.86	221.20	223.29	332.34	830.00
		3/8"	9.53	78.81	157.63	234.23	236.44	351.92	879.00
			10.00	82.70	165.40	245.78	248.10	369.27	922.00
		12.00	99.24	198.48	294.93	297.72	443.13	1.106.00	
	1/2"	12.70	105.03	210.06	312.14	315.09	468.98	1.171.00	

FORMATO DE LÁMINAS MÁS COMERCIALES EN COLOMBIA

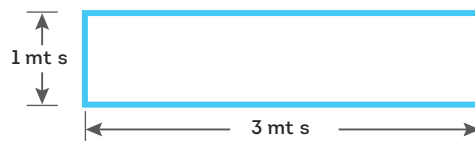

1

1.4 LÁMINAS COLD ROLLED Ó LAMINADAS EN FRÍO

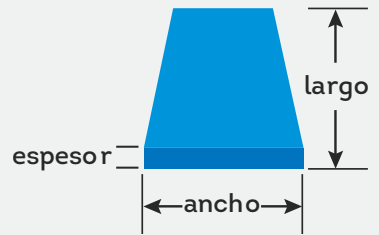

LÁMINAS DE ACERO LAMINADAS EN FRÍO								ESPECIFICACIONES TÉCNICAS						
CALIDADES MAS COMUNES		COMPOSICIÓN QUÍMICA						PROPIEDADES MECÁNICAS				APLICACIONES MAS FRECUENTES		
ASTM	JIS G 3141	L	C	MN	P	S	SI	LÍMITE ELÁSTICO	RESISTENCIA A LA TRACCIÓN	% ALAR	DUREZA			
A 366	SPCC	MIN						-	-	-	-	32	-	General comercial
		MAX	0,12	0,50	0,04	0,05		-	-	28Kg/mm2		39	-	
A 619	SPCD	MIN						-	-	-	-	34	-	Estampado profundo
		MAX	0,10	0,45	0,04	0,04		-	-	28Kg/mm2		41	-	
A 620	SPCE	MIN						-	-	-	-	36	-	Estampado extraprofundo
		MAX	0,08	0,40	0,03	0,03		-	-	28Kg/mm2		43	-	

DIMENSIONES Y PESOS DE LAMINAS COMERCIALES										
LÁMINAS EN FRÍO	ESPESOR M.S.G		1.0 X 2.0MTS		1.22 X 2.44MTS 4' X 8'	ESPESOR U.S.G.		1.0 X 2.0MTS		1.22 X 2.44MTS 4' X 8'
	CALIBRE	MILIMETRO	Kg.	Kg.	Kg.	CALIBRE	MILIMETRO	Kg.	Kg.	Kg.
	26	0.455	3.66	7.32	10.89	26	0.476	3.74	7.47	11.12
25	0.531	4.27	8.54	12.71	25	0.556	4.36	8.73	12.99	
24	0.607	4.88	9.76	14.53	24	0.635	4.98	9.97	14.84	
23	0.683	5.49	10.98	16.35	23	0.714	5.60	11.21	16.68	
22	0.759	6.10	12.21	18.17	22	0.794	6.23	12.46	18.55	
21	0.876	7.04	14.09	20.97	21	0.883	6.93	13.86	20.63	
20	0.912	7.33	14.67	21.83	20	0.952	7.47	14.95	22.24	
19	1.062	8.54	17.08	25.42	19	1.111	8.72	17.44	25.96	
18	1.214	9.76	19.52	29.06	18	1.27	9.97	19.94	29.68	
16	1.519	12.21	24.43	36.36	16	1.588	12.46	24.93	37.11	

FORMATOS DE LÁMINAS MÁS COMERCIALES EN COLOMBIA

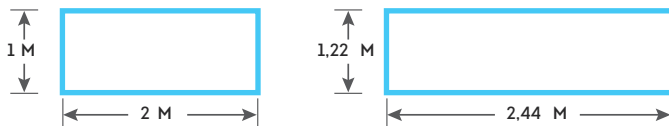

1

1.5 LÁMINAS GALVANIZADAS

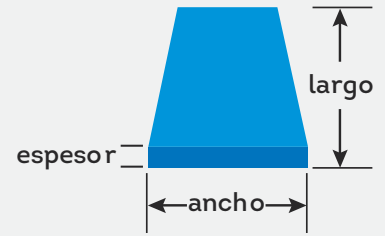

LÁMINAS GALVANIZADAS								ESPECIFICACIONES TÉCNICAS						
CALIDADES MAS COMUNES		COMPOSICIÓN QUÍMICA						PROPIEDADES MECÁNICAS				APLICACIONES MAS FRECUENTES		
ASTM	JIS G 3141	L	C	MN	P	S	SI	LÍMITE ELÁSTICO	RESISTENCIA A LA TRACCIÓN	% ALARGA	DUREZA			
A 366	SPCC	MIN						-	-	-	-	32	-	General comercial
		MAX	0.12	0.50	0.04	0.05		-	-	28Kg/mm2		39	-	
A 619	SPCD	MIN						-	-	-	-	34	-	Estampado profundo
		MAX	0.10	0.45	0.04	0.04		-	-	28Kg/mm2		41	-	
A 620	SPCE	MIN						-	-	-	-	36	-	Estampado extraprofundo
		MAX	0.08	0.40	0.03	0.03		-	-	28Kg/mm2		43	-	

DIMENSIONES Y PESOS DE LAMINAS DE ACERO GALVANIZADAS

LÁMINAS GALVANIZADAS	ESPESOR		M2	10X 2.0 M	1.0 X 3.0 M	1.0 X 6.0 M	ESPESOR		M2	1.2 X 1.0 M	1.20 x 2.44 M	1.22 X 2.44 M 4' x 8'
	CALIBRE	MILIMETRO	Kg.	Kg.	Kg.	Kg.	CALIBRE	MILIMETRO	Kg.	Kg.	Kg.	Kg.
	31.00	0.27	2.27	4.55	6.82	13.65	31.00	0.27	2.27	2.73	6.66	6.77
30.00	0.30	2.51	5.02	7.53	15.06	30.00	0.30	2.51	3.01	7.35	7.47	
29.00	0.34	2.87	5.74	8.61	17.22	29.00	0.34	2.87	3.44	8.40	8.54	
28.00	0.35	2.93	5.86	8.79	17.58	28.00	0.35	2.93	3.52	8.58	8.72	
27.00	0.42	3.49	6.98	10.47	20.95	27.00	0.42	3.49	4.19	10.22	10.39	
26.00	0.45	3.71	7.43	11.14	22.29	26.00	0.45	3.71	4.46	10.88	11.06	
25.00	0.53	4.38	8.77	13.15	26.30	25.00	0.53	4.38	5.26	12.84	13.05	
24.00	0.60	4.89	9.79	14.68	29.37	24.00	0.60	4.89	5.87	14.33	14.57	
23.00	0.68	5.57	11.14	16.72	33.43	23.00	0.68	5.57	6.69	16.32	16.59	
22.00	0.70	5.71	11.43	17.14	34.29	22.00	0.70	5.71	6.86	16.73	17.01	
21.00	0.88	7.15	14.30	21.46	42.91	21.00	0.88	7.15	8.58	20.94	21.29	
20.00	0.90	7.28	14.57	21.85	43.71	20.00	0.90	7.28	8.74	21.33	21.59	
19.00	1.06	8.60	17.19	25.79	51.58	19.00	1.06	8.60	10.32	25.17	25.59	
18.00	1.20	9.69	19.39	29.08	58.17	18.00	1.20	9.69	11.63	28.39	28.86	
17.00	1.37	11.04	22.09	33.13	66.27	17.00	1.37	11.04	13.25	32.34	32.88	
16.00	1.50	12.05	24.10	36.15	72.30	16.00	1.50	12.05	14.46	35.28	35.87	
15.00	1.71	13.73	27.46	41.19	82.37	15.00	1.71	13.73	16.47	40.20	40.87	
14.00	1.90	15.19	30.38	45.57	91.14	14.00	1.90	15.19	18.23	44.48	45.22	
13.00	2.28	18.21	36.42	54.64	109.27	13.00	2.28	18.21	21.85	53.32	54.21	
12.00	2.50	19.90	39.79	59.69	119.37	12.00	2.50	19.90	23.87	58.25	59.22	
11.00	3.00	23.75	47.49	71.24	142.47	11.00	3.00	23.75	28.49	69.53	70.68	

FORMATOS DE LÁMINAS MÁS COMERCIALES EN COLOMBIA

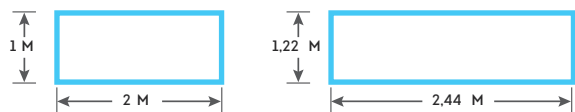

1

1.6 RESUMEN DE LÁMINAS MÁS COMERCIALES

RANGO (ESPEORES)			ALFAJOR	ASTM A-36				ASTM A-131A		ASTM A-283C		A-516 70		A-572 50		A-588 B
CAL.	MILM.	PULG.	1.0X3.0 MT	1.2X2.4 MT	1.2X6 MT	1.83X6.09 MT (6X20)	2.44X6.0 MT (8X20)	1.83X6.09 MT (6X20)	2.44X6.09 MT (8X20)	1.83X6.09 MT (6X20)	2.44X6.09 MT (8X20)	2.44X6.09 MT (8X20)	2.44X8.534 (8X28)	2.44X6.09 MT (8X20)	2.44X12.192 MT (8X40)	2.44X6.09 MT (8X20)
16	1.5			1.2x2.4mt												
14	1.9			1.2x2.4mt												
	2.5		1.0x3.0mt	1.2x2.4mt	1.2x6mt											
12	2.66			1.2x2.4mt												
11	3		1.0x3.0mt	1.2x2.4mt	1.2x6mt											
	3.17	1/8"		1.2x2.4mt	1.2x6mt											
	4		1.0x3.0mt	1.2x2.4mt	1.2x6mt											
	4.5		1.0x3.0mt	1.2x2.4mt	1.2x6mt	1.83 x 6.09mt										
	4.76	3/16"				1.83 x 6.09mt		1.83 x 6.09mt		1.83 x 6.09mt						
	5		1.0x3.0mt	1.2x2.4mt	1.2x6mt											
	6		1.0x3.0mt	1.2x2.4mt	1.2x6mt	1.83 x 6.09mt	2.44 x 6.09mt									
6.35	1/4"					1.83 x 6.09mt	2.44 x 6.09mt	1.83 x 6.09mt	2.44 x 6.09mt	1.83 x 6.09mt	2.44 x 6.09mt	2.44 x 6.09mt	2.44 x 8.534	2.44 x 6.09mt	2.44 x 12.192	2.44 x 6.09mt
8	5/16"		1.0x3.0mt	1.2x2.4mt	1.2x6mt	1.83 x 6.09mt	2.44 x 6.09mt	1.83 x 6.09mt	2.44 x 6.09mt	1.83 x 6.09mt	2.44 x 6.09mt	2.44 x 6.09mt	2.44 x 8.534	2.44 x 6.09mt	2.44 x 12.192	2.44 x 6.09mt
9				1.2x2.4mt	1.2x6mt	1.83 x 6.09mt	2.44 x 6.09mt									
9.53	3/8"					1.83 x 6.09mt	2.44 x 6.09mt	1.83 x 6.09mt	2.44 x 6.09mt	1.83 x 6.09mt	2.44 x 6.09mt	2.44 x 6.09mt	2.44 x 8.534	2.44 x 6.09mt	2.44 x 12.192	2.44 x 6.09mt
12				1.2x2.4mt	1.2x6mt	1.83 x 6.09mt	2.44 x 6.09mt									
12.7	1/2"					1.83 x 6.09mt	2.44 x 6.09mt	1.83 x 6.09mt	2.44 x 6.09mt	1.83 x 6.09mt	2.44 x 6.09mt	2.44 x 6.09mt	2.44 x 8.534	2.44 x 6.09mt	2.44 x 12.192	2.44 x 6.09mt
15						1.83 x 6.09mt	2.44 x 6.09mt									
15.88	5/8"							2.44 x 6.09mt		2.44 x 6.09mt	2.44 x 6.09mt	2.44 x 8.534	2.44 x 6.09mt	2.44 x 12.192	2.44 x 6.09mt	
19						2.44 x 6.09mt										
19.05	3/4"							2.44 x 6.09mt		2.44 x 6.09mt	2.44 x 6.09mt	2.44 x 8.534	2.44 x 6.09mt	2.44 x 12.192	2.44 x 6.09mt	
22																
22.23	7/8"											2.44 x 6.09mt	2.44 x 8.534	2.44 x 6.09mt	2.44 x 12.192	2.44 x 6.09mt
25						1.83 x 6.09mt	2.44 x 6.09mt									
25.4	1"							2.44 x 6.09mt		2.44 x 6.09mt	2.44 x 6.09mt	2.44 x 8.534	2.44 x 6.09mt	2.44 x 12.192	2.44 x 6.09mt	
28.5	1 1/8"									2.44 x 6.09mt	2.44 x 6.09mt	2.44 x 8.534	2.44 x 6.09mt	2.44 x 12.192	2.44 x 6.09mt	
31.75	1 1/4"						2.44 x 6.09mt					2.44 x 6.09mt	2.44 x 8.534	2.44 x 6.09mt	2.44 x 12.192	2.44 x 6.09mt
32							2.44 x 6.09mt									
38							2.44 x 6.09mt									
38.1	1 1/2"						2.44 x 6.09mt				2.44 x 6.09mt	2.44 x 8.534	2.44 x 6.09mt	2.44 x 12.192	2.44 x 6.09mt	
50							2.44 x 6.09mt									
50.8	2"													2.44 x 6.09mt	2.44 x 12.192	2.44 x 6.09mt
63							2.44 x 6.09mt									
63.5	2 1/2"															
75							2.44 x 6.09mt									
76.2	3"															
100							2.44 x 6.09mt									
101.6	4"															
TOTALES			7	13	10	12	18	5	7	5	7	11	11	10	10	10
GENERAL			136													

A close-up photograph of a stack of steel bars. The ends of the bars are visible, showing a dark, weathered metal surface with a bright yellow paint coating. The bars are arranged in a slightly overlapping manner, creating a sense of depth. The background is blurred, focusing attention on the texture and color of the steel ends.

2

***BARRAS DE
ACERO***

2

2.0 CALIDADES DE ACEROS LARGOS MÁS FRECUENTES EN COLOMBIA

Usos y aplicaciones: Acero de refuerzo para construcción y ornamentación						
COMPOSICIÓN QUÍMICA (Análisis de colada %)						
Denominación	C Máx.	Mn Máx.	P Max.	S Max.	Si Max.	CE
NTC - 2289 (PDR - 60*)	0.30 Máx.	1.5 Máx.	0.035	0.045	0.5	0,55Máx.
NTC - 161			0.05	0.06	-	-

* CORRUGADOS: Para construcciones con diseño sismorresistente.

PROPIEDADES MECÁNICAS					
DESIGNACIÓN	UNIDADES	LÍMITE DE FLUENCIA	A LA TRACCIÓN	% ELONGACIÓN EN 200 mm MÍN.	
				No.	%
	kgf/mm2	42/55	56 min	2-jun	14
NTC - 2289	lbf/Pulg2	60.000/78.000	80.000 min	7-oct	12
(PDR - 60*)	Mpa	420/540	550 min	6 a 12mm	14
NTC - 161, AH-22	kgf/mm2	22/55	34 min		20
NTC - 161, AH-24	kgf/mm2	24/55	37 min		18
NTC - 161, AH-28	kgf/mm2	28/55	49 min		11

Para la calidad PDR-60, la relación resistencia/límite de fluencia es ≥ 1.25 .

2

2.1 BARRAS CORRUGADAS

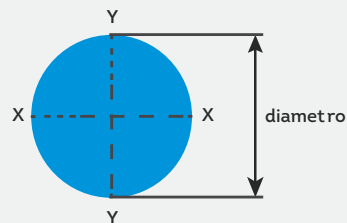

PROPIEDADES MECÁNICAS	
LÍMITE DE FLUENCIA	RESISTENCIA A LA TRACCIÓN
Mínimo 420 MPA 60.000 P.S.I 24 KgF/mm ²	Mínimo 550 M.P.A 80.000 P.S.I
Mínimo 540 MPA 78.000 P.S.I 55 KgF/mm ²	(Distancia entre marcas 200 mm)
NÚMERO DE DESIGNACIÓN DE LAS BARRAS	
BARRAS	% DE ALARGAMIENTO
2, 3, 4, 5, 6	14%
7, 8, 9, 10, 11	12%

DIMENSIONES NOMINALES Y TOLERANCIAS MAXIMAS DE LAS BARRAS CORRUGADAS											
DESIGNACIÓN		DIAMETRO NOMINAL	AREA DE LA SECCIÓN	PERIMETRO	DISTANCIA PROMEDIO MAX. RESALTES	ALTURA MAX. RESALTES Y VENAS	ANCHO MAX. DE VENAS	MASA POR METRO LINEAL	TOLERANCIA EN LONG.	TOLERANCIA EN PESO	
										LOTE	INDIVI.
No.	PULG.	MM	MM ²	MM	MM	MM	MM	KG/M.	MM	%	%
3	3/8	9.53	71.40	30.00	6.70	0.42	3.60	0.57	-0.00	4	6
									+1.25		
4	1/2	12.70	129.00	39.90	8.90	0.51	4.80	1.00	-0.00	4	6
									+1.25		
5	5/8	15.90	200.00	49.90	11.10	0.63	6.00	1.56	-0.00	4	6
									+1.25		
6	3/4	19.10	284.00	59.80	13.30	0.95	7.20	2.25	-0.00	4	6
									+1.25		
7	7/8	22.20	387.00	69.80	15.60	1.11	8.40	3.06	-0.00	4	6
									+1.25		
8	1	25.40	510.00	79.80	17.80	1.27	9.70	4.00	-0.00	4	6
									+1.25		
9	1 1/8	28.70	645.00	90.00	20.00	1.43	10.90	5.06	-0.00	4	6
									+1.25		
10	1 1/4	32.30	819.00	101.40	22.40	1.60	12.20	6.35	-0.00	4	6
									+1.25		
11	1 3/8	35.80	1,006.00	112.50	25.20	1.80	13.70	8.04	-0.00	4	6
									+1.25		

LARGOS MÁS COMERCIALES EN COLOMBIA

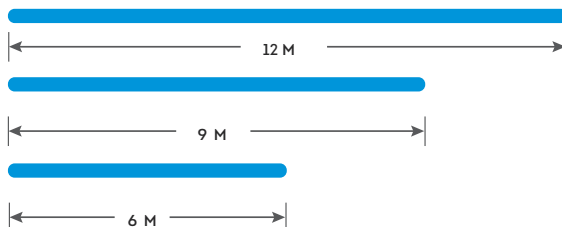

2

2.2 VARILLAS LISAS Ó REDONDOS LISOS

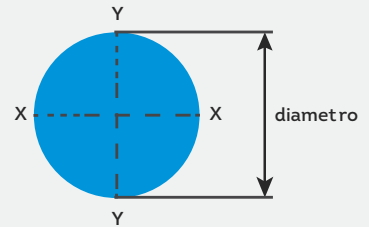

PROPIEDADES MECANICAS

LIMITE DE FLUENCIA	RESISTENCIA A LA TRACCIÓN
Mínimo 236 MPA 34.1 00 P.S.I.	Mínimo 362 M.P.A 53.000 G36 P.S.I.
Máximo 538 MPA 78.1 00 P.S.I.	Alargamiento Mínimo 18%
	(Distancia entre marcas 200 mm.)

DIMENSIONES

DIÁMETRO NOMINAL

PULGADAS		MM.	AREA SECCIÓN MM2	PERÍMETRO MM	MASA KG/M.	FORMA SUMINISTRO
No.						
2	1/4	6.35	32	19.9	0.25	Rollos
3	3/8	9.52	71.2	29.9	0.56	Rollos
		10.50	86.60	33.00	0.68	Barras
		12.00	113.10	37.00	0.89	Barras
4	1/2	12.70	126.70	39.90	1.00	Barras
		15.00	176.80	47.20	1.39	Barras
5	5/8	15.89	197.80	49.80	1.55	Barras
6	3/4	19.05	285.00	59.80	2.24	Barras
7	7/8	22.22	387.80	69.80	3.05	Barras
8	1	25.40	506.70	79.70	3.99	Barras
9	1 1/8"	28.57	645	90	5.06	Barras
10	1 1/4"	31.75	819	101.3	6.404	Barras

LARGO MÁS COMERCIAL EN COLOMBIA



2

2.3 PLATINAS Y CUADRADOS

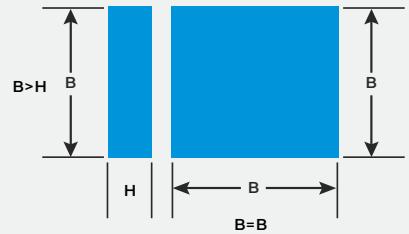

PLATINAS				
MEDIDAS	KG./M	KG./ UNID.	UNID/ PAQUETE	AREA
HXB		6M.	6M.	CM2
1/8x1/2	0.32	1.92	560	0.40
1/8x5/8	0.40	2.40	450	0.50
1/8x3/4	0.48	2.88	375	0.60
1/8x1	0.63	3.78	280	0.81
1/8x1.1/4	0.79	4.74	225	1.01
1/8x1.1/2	0.95	5.70	180	1.21
1/8x2	1.27	7.62	140	1.61
1/8x2.1/2	1.58	9.48	112	2.01
1/8x3	1.90	11.40	91	2.42
3/16x1/2	0.48	2.88	375	0.60
3/16x5/8	0.60	3.60	300	0.76
3/16x3/4	0.71	4.26	240	0.91
3/16x1	0.95	5.70	180	1.21
3/16x1.1/4	1.19	7.14	150	1.51
3/16x1.1/2	1.43	8.58	120	1.81
3/16x2	1.90	11.40	90	2.42
3/16x2.1/2	2.38	14.28	75	3.02
3/16x3	2.85	17.10	60	3.63
3/16x4	3.80	22.80	45	4.84
1/4x1/2	0.64	3.84	280	0.81
1/4x5/8	0.79	4.74	225	1.01
1/4x3/4	0.95	5.70	180	1.21
1/4x1	1.27	7.62	140	1.61
1/4x1.1/4	1.59	9.54	110	2.02
1/4x1.1/2	1.90	11.40	90	2.42
1/4x2	2.53	15.18	70	3.23
1/4x2.1/2	3.17	19.02	56	4.03
1/4x3	3.80	22.80	45	4.84
1/4x4	5.07	30.42	34	6.45
3/8x1	1.90	11.40	91	2.42
3/8x1.1/2	2.85	17.10	60	3.63
3/8x2	3.80	22.80	45	4.84
3/8x2.1/2	4.75	28.50	36	6.05
3/8x3	5.70	34.20	30	7.25
3/8x4	7.60	45.60	24	9.67

PLATINAS				
MEDIDAS	KG./M	KG./ UNID.	UNID/ PAQUETE	AREA
HXB		6M.	6M.	CM2
1/2x1	2.53	15.18	70	3.23
1/2x1.1/2	3.80	22.80	45	4.84
1/2x2	5.07	30.42	34	6.45
1/2x2.1/2	6.33	37.98	28	8.06
1/2x3	7.60	45.60	24	9.68
1/2x4	10.13	60.78	17	12.90
1/2x5	12.66	75.96	14	16.13
1/2x6	15.20	91.20	11	19.35
5/8x1.1/2	4.75	18.50	36	6.05
5/8x2	6.33	37.98	27	8.06
5/8x2.1/2	7.92	47.52	22	10.06
5/8x3	9.50	57.00	18	12.09
5/8x4	12.66	75.96	14	16.12
5/8x5	15.83	94.98	11	20.15
5/8x6	18.99	113.94	9	24.19
3/4x1.1/2	5.70	34.20	30	7.26
3/4x2	7.60	45.60	22	9.68
3/4x3	11.40	68.40	15	15.52
3/4x4	15.20	91.20	11	19.35
3/4x5	18.99	113.94	9	24.19
3/4x6	22.79	136.74	8	29.03
7/8x2	8.87	53.22	19	11.29
7/8x3	13.30	79.80	13	16.93
7/8x4	17.73	106.38	10	22.58
7/8x5	22.16	132.96	8	26.22
7/8x6	26.59	159.54	7	33.86
1.x2	10.13	60.78	17	12.90
1.x3	15.20	91.20	11	19.35
1.x4	20.26	121.56	9	25.81
1.x5	25.33	151.98	7	32.26
1.x6	30.39	182.34	6	38.71

CUADRADOS				
MEDIDAS	KG./M	KG. / UNID.	UNID/ PAQUETE	AREA
B=B		6M.		CM2
9mm.	0.64	3.84	270	0.81
11mm.	0.95	5.70	180	1.21
12mm.	1.13	6.78	150	1.44
1/2"	1.27	7.62	140	1.61
9/16"	1.60	9.60	105	2.04
5/8"	1.98	11.88	90	2.52
3/4"	2.85	17.10	60	3.63
7/8"	3.88	23.28	44	4.94
1"	5.07	30.42	33	6.45

LARGOS MÁS COMERCIALES EN COLOMBIA



2

2.4 GRAFILES Y MALLAS

TIPO	REFERENCIA	SEPARACIÓN		DIÁMETRO		ÁREA CM2/MIL		No. VARILLA		PESO EN KG
		LONG	TRANSV	LONG	TRANSV	LONG	TRANSV	LONG	TRANSV	
ARMADURAS EN UNA DIRECCIÓN	Mr=0.47	30	40	4.00	4.00	0.42	0.31	8.	16.	8.48
	Mr=0.50	25	36	4.00	4.00	0.50	0.36	10.	18.	10.13
	Mr=0.83	20	25	4.00	4.00	0.63	0.60	13.	24.	13.31
	Mr=0.84	15	25	4.00	4.00	0.84	0.50	16.	24.	15.90
	Mr=1.06	15	25	4.00	4.00	1.06	0.50	16.	24.	17.68
	Mr=1.58	16	25	4.50	4.00	1.58	0.50	16.	24.	23.45
	Mr=2.21	15	25	5.40	4.00	2.21	0.50	16.	24.	30.64
	Mr=2.57	16	26	6.50	5.00	2.67	0.78	16.	24.	37.68
	Mr=2.83	10	25	7.00	5.00	2.83	0.78	24.	24.	40.66
	Mr=3.35	15	20	6.00	5.00	3.35	0.98	16.	30.	48.78
	Mr=3.78	15	25	8.00	6.00	3.78	0.78	16.	24.	51.41
	Mr=4.42	10	25	7.50	5.50	4.42	0.95	24.	24.	60.52
	Mr=5.03	10	20	8.00	6.00	5.03	1.42	24.	30.	72.53
Mr=5.67	10	20	8.50	6.00	5.67	1.42	24.	30.	79.73	

ÁREA DE ACERO POR METRO DE LONGITUD EN Kg/m

Ø (mm)	ÁREA 1 VARILLA cm ²	ESPACIAMIENTO (cm)												
		5.0 10 d	7.5 15 d	10.0	12.5	15.0	17.5	20.0	22.5	25.0	27.5	30.0	32.5	35.0
3.0	0.056	1.12	0.75	0.56	0.45	0.47	0.32	0.28	0.25	0.22	0.20	0.19	0.17	0.16
3.5	0.076	1.51	1.01	0.76	0.60	0.50	0.42	0.38	0.34	0.30	0.27	0.25	0.23	0.22
4.0	0.099	1.97	1.32	0.99	0.79	0.66	0.56	0.49	0.44	0.39	0.36	0.33	0.30	0.28
4.5	0.125	2.50	1.67	1.25	1.00	0.80	0.71	0.62	0.56	0.50	0.45	0.42	0.38	0.36
5.0	0.154	3.09	2.06	1.54	1.23	1.03	0.88	0.77	0.69	0.62	0.56	0.51	0.47	0.44
5.5	0.187	3.73	2.49	1.87	1.49	1.24	1.07	0.93	0.83	0.75	0.68	0.62	0.57	0.53
6.0	0.222	4.44	2.96	2.22	1.77	1.48	1.27	1.11	0.99	0.86	0.81	0.74	0.88	0.63
6.5	0.261	5.21	3.48	2.61	2.09	1.74	1.49	1.30	1.16	1.04	0.95	0.87	0.80	0.74
7.0	0.302	6.05	4.03	3.02	2.42	2.02	1.73	1.51	1.34	1.21	1.10	1.01	0.93	0.86
7.5	0.347	6.94	4.63	3.47	2.78	2.31	1.98	1.74	1.54	1.39	1.26	1.16	1.07	0.99
8.0	0.395	7.90	5.27	3.95	3.16	2.63	2.26	1.97	1.76	1.58	1.44	1.32	1.22	1.13
8.5	0.446	8.92	5.94	4.46	3.57	2.97	2.55	2.23	1.98	1.78	1.62	1.49	1.37	1.27
9.0	0.500	10.00	6.66	5.00	4.00	3.33	2.86	2.50	2.22	2.00	1.82	1.67	1.54	1.43
9.5	0.557	11.14	7.42	5.57	4.45	3.71	3.18	2.78	2.47	2.23	2.02	1.86	1.71	1.59
10.0	0.617	12.34	8.23	6.17	4.94	4.11	3.53	3.09	2.74	2.47	2.24	2.06	1.90	1.76

2

2.5 MALLAS ELECTROSOLDADAS

Las mallas electrosoldadas que produce Steckerl Aceros S A S. son un producto prefabricado con alambres de acero trellados de alta resistencia, corrugados, longitudinales y transversales, colocados mediante un proceso de electrosoldadura formando ángulos rectos. Fabricación de mallas en medidas estándar y especiales con ancho hasta 3 metros y longitudes hasta 6 metros.

TIPO	REFERENCIA	SEPARACIÓN		DIÁMETRO		ÁREA CM2/MIL		No. VARILLAS		PESO EN KG
		LONG	TRANSV	LONG	TRANSV	LONG	TRANSV	LONG	TRANSV	
ARMADURAS EN DOS DIRECCIONES	Mc-0.47	10	30	4.00	4.00	0.47	0.47	8	20	10.45
	Mc-0.64	20	20	4.00	4.00	0.64	0.64	13	30	14.71
	Mc-0.84	15	15	4.00	4.00	0.84	0.84	16	40	18.81
	Mc-1.08	15	15	4.50	4.50	1.06	1.06	16	40	23.75
	Mc-1.31	15	15	5.00	5.00	1.31	1.31	16	40	29.26
	Mc-1.59	15	15	5.50	5.50	1.59	1.59	16	40	35.53
	Mc-1.89	15	15	6.00	6.00	1.89	1.89	16	40	42.18
	Mc-2.21	15	15	6.50	6.50	2.21	2.21	16	40	49.59
	Mc-2.57	15	15	7.00	7.00	2.57	2.57	16	40	57.38
	Mc-2.96	15	15	7.50	7.50	2.95	2.95	16	40	65.93
	Mc-3.35	15	15	8.00	8.00	3.35	3.35	16	40	73.05
	Mc-3.78	15	15	8.50	8.50	3.78	3.78	16	40	84.5
	Mc-4.42	10	10	7.50	7.50	4.42	4.42	24	60	98.9
	Mc-5.67	10	10	8.50	8.50	5.67	5.67	24	60	126.83
	Mc-4.67	15	15	9	9	4.2	4.2	16	40	95
	Mc-5.18	15	15	10	10	5.18	5.18	16	40	117.8
	**Mc-6.27	15	15	11	11	6.27	6.27	16	40	142.5
	**Mc-7.76	15	15	12	12	7.52	7.52	16	40	169.48

**Fabricado con material laminado en caliente en caliente o frío a opción de STECKERL ACEROS.

Ø (mm)	ÁREA 1 VARILLA cm ²	ÁREA DE ACERO POR METRO DE LONGITUD EN cm ² /m												
		ESPACIAMIENTO (cm)												
		5.0 10 d	7.5 15 d	10.0	12.5	15.0	17.5	20.0	22.5	25.0	27.5	30.0	32.5	35.0
3.0	0.071	0.94	0.71	1.42	0.57	0.47	0.40	0.36	0.32	0.28	0.25	0.23	0.21	0.20
3.5	0.098	1.28	0.96	1.92	0.77	0.64	0.55	0.48	0.43	0.38	0.35	0.32	0.30	0.27
4.0	0.126	1.68	1.26	2.51	1.01	0.84	0.72	0.63	0.56	0.50	0.46	0.42	0.39	0.36
4.5	0.159	2.12	1.59	3.18	1.27	1.06	0.91	0.80	0.71	0.64	0.58	0.53	0.49	0.45
5.0	0.196	2.62	1.96	3.93	1.57	1.31	1.12	0.96	0.87	0.79	0.71	0.65	0.60	0.56
5.5	0.238	3.17	2.38	4.75	1.90	1.58	1.36	1.19	1.06	0.95	0.86	0.79	0.73	0.68
6.0	0.283	3.77	2.83	5.65	2.26	1.88	1.62	1.41	1.26	1.13	1.03	0.94	0.87	0.81
6.5	0.332	4.42	3.32	6.64	2.65	2.21	1.90	1.66	1.47	1.33	1.21	1.11	1.02	0.95
7.0	0.385	5.13	3.85	7.70	3.08	2.57	2.20	1.92	1.71	1.54	1.40	1.28	1.18	1.10
7.5	0.442	5.89	4.42	8.84	3.53	2.95	2.52	2.21	1.96	1.77	1.61	1.47	1.36	1.26
8.0	0.503	6.70	5.03	10.05	4.02	3.35	2.87	2.51	2.23	2.01	1.83	1.68	1.55	1.44
8.5	0.567	7.57	5.67	11.35	4.54	3.78	3.24	2.84	2.52	2.27	2.06	1.89	1.75	1.62
9.0	0.636	8.48	6.36	12.72	5.09	4.24	3.64	3.18	2.83	2.54	2.31	2.12	1.96	1.82
9.5	0.709	9.45	7.09	14.18	5.67	4.73	4.05	3.54	3.15	2.64	2.58	2.36	2.18	2.03
10.0	0.785	10.47	7.85	15.71	6.28	5.24	4.49	3.93	3.49	3.14	2.86	2.62	2.42	2.24
11	0.95	19.00	12.67	9.50	7.60	6.33	5.43	4.75	4.22	3.80	3.45	3.17	2.92	2.71
12	1.13	12.62	15.08	11.31	9.05	7.54	6.46	5.66	5.03	4.52	4.11	3.17	3.48	3.23

2

2.5 MALLAS ELECTROSOLDADAS

VENTAJAS EN EL USO DE MALLAS ELECTROSOLDADAS

- Mayor eficiencia de producción en sistemas industrializados de construcción.
- Amplia gama de configuración de mallas especiales para su refuerzo, longitudinal y transversal.
- Ahorro de materiales por eliminación de amarres, cortes, enderezado y ganchos. Facilidad de almacenaje.
- Mayor rapidez en la recuperación de formaletería en los sistemas industrializados por facilidad de manejo.
- Calidad uniforme en los aceros, exactitud en el espaciado y el en diámetro, lo que facilita la labor de supervisión e interventoría.
- Garantiza una mejor distribución del acero para el control de agrietamiento del concreto.
- Garantiza la continuidad del refuerzo donde se esté trabajando, cumple estrictamente con las normas y el aseguramiento de la calidad.

USOS

- Lozas macizas y aligeradas.
- Pisos de concreto reformado.
- Cubiertas.
- Canales, Box culvert.
- Muros de contención, tanques, piscinas.
- Tuberías de concreto.
- Revestimiento de túneles prefabricados.
- En sistemas constructivos industrializados con muros portantes y placas.
- En mampostería estructural.

NORMA TÉCNICA NTC 2289			
ESPECIFICACIÓN	MALLA ELECTROSOLDADA	GRAFILADO	LISO
LÍMITE INFLUENCIA (Mpa)	485	515	485
RESISTENCIA A LA TRACCIÓN (Mpa)	550	585	550

Nuestras mallas electrosoldadas cumplen con la resolución 0227 del Ministerio de Comercio Industria y Turismo.

2

2.6 ACERO FIGURADO

El acero figurado es acero de refuerzo para concreto armado que ha sido cortado y figurado en una planta especializada, identificado y transportado a la obra, listo para armar. Se realiza siguiendo las cartillas de despiece y se figura con criterio técnico y máquinas especializadas en cortes y dobleces. Este método presenta todas las ventajas ante el convencional, pues ahorra tiempo y dinero porque brinda un producto preparado, totalmente controlable en la obra y con cero desperdicios.

DIMENSIONES DE LOS GANCHOS NORMALES



ACERO PSI	BARRA No.	GANCHO 90°			GANCHO 180°		
60.000	d. b.	D	L	C	L	C	M
	12 mm y 1/2"	76	181	203	160	116	102
	16 mm y 5/8"	95	227	254	200	129	127
	18 mm y 3/4"	115	273	306	240	153	153
	22 mm y 7/8"	133	317	355	279	176	178
	25 mm y 1"	152	363	406	319	203	203
	32 mm y 1 1/4"	258	480	549	508	291	323
ACERO PSI	BARRA No.	GANCHO 90°			GANCHO 180°		
40.000	d. b.	D	L	C	L	C	M
	3/8"	48	133	147	136	98	67
	1/2"	64	178	197	160	109	89
	5/8"	80	223	246	185	121	111
	3/4"	96	267	296	219	143	134
	7/8"	111	311	344	256	167	155
	1"	127	356	394	292	191	178
	1 1/8"	143	400	443	329	215	200
	1 1/8"	156	437	484	359	234	218

2

2.7 RESUMEN DE BARRAS MÁS COMERCIALES

RANGO (ESPEORES)		BARRAS CORR.	BARRAS LISAS	PLATINAS	CUADRADOS	GRAFILES
MILIMETROS	PULGADAS					
2<e<3 (mm)	1/8"			1/8" x 1/2,5/8,3/4,1 (4) 1/8" x 11/4,11/2,2 (3)		3 mm
3.5<e<4 (mm)						3.5, 4 mm (2)
4.5<e<5 (mm)	3/16"			3/16" x 1/2,5/8,3/4,1 (4) 3/16" x 11/4,11/2,2,21/2,3 (5)		4.5, 5mm (2)
5<e<6.35 (mm)	1/4"	1/4"	1/4"	1/4" x 1/2,5/8,3/4,1 (4) 1/4" x 11/2,2,21/2,3,4 (5)		5.5, 6mm (2)
6.5<e<9.53 (mm)	3/8"	3/8"	9mm 3/8"	3/8" x 1, 11/2, 2 (3) 3/8" x 21/2", 3, 4 (3)	9mm 3/8"	7, 7.5mm (2) 8,8.5,9mm (3)
10<e<12.7 (mm)	1/2"	1/2"	10 mm 1/2"	1/2" x 1,11/2,2,21/2 (4) 1/2" x 3, 4, 5, 6 (4)	11mm 12mm 1/2"	
13<e<15.88 (mm)	5/8"	5/8"	15mm 5/8"	5/8" x 3 5/8" x 4 5/8" x 5, 6 (2)	9/16" 5/8"	
16<e<19.05 (mm)	3/4"	3/4"	3/4"	3/4" x 4 3/4" x 5 3/4" x 6	3/4"	
20<e<22.23 (mm)	7/8"	7/8"	7/8"	7/8" x 4, 6 (2)	7/8"	
23<e<25.4 (mm)	1"	1"	1"	1" x 3 1" x 4 1" x 5 1" x 6	1"	
26<e<28.7	11/8"	11/8"				
29<e<31.75 (mm)	11/4"	11/4"				
32<e<34.9 (mm)	13/8"	13/8"				
TOTALES GENERAL		10	12	52 96	10	12

() Nota: Los paréntesis indican el número de referencias por espesor, cuando es más de una.

Nota: Para identificar que productos debían hacer parte del presente resumen, nuestra empresa realizó un análisis basados en su experiencia en el sector. Es posible que en el mercado existan otros elementos de acero de uso estructural que también son comerciales en Colombia pero que no están incluidos en este resumen.

Los productos sombreados SON de nuestra comercialización habitual
Otros productos venta solo bajo pedido, sujeto a entrega del productor



3

***PERFILES
DE ACERO***

3

PERFIL TIPO EUROPEO EN 10025 - 1990

Norma Europea (EN)	S 355 J2 G3 Z35
S	Tipo de Acero S = Acero Estructural
355	Propiedades Mecánicas 355 Límite elástico mínimo en MPA
J2	Designación de calidad con respecto a la soldabilidad y resistencia a la fractura frágil. JR Longitudinal 27J + 20 °C JO Longitudinal 27J - 0 °C J2 Longitudinal 27J - 20 °C K2 Longitudinal 40J - 20 °C
G3	Método de desoxidación G1 No calmado G2 Calmado G3 Condición especial
Z 35	Propiedades frente al desgarro laminar se expresa en términos de reducción del área. Z15 min 15% Z25 min 25% Z35 min 35%
M	Estado de entrega + M_ Laminado Termomecánico + N_ Laminado de Normalización + L_ Para bajas temperaturas + W_ Resistentes a la corrosión atmosférica + AR_ Laminado + H_ Para altas temperaturas

El Comité Europeo de Normalización (CEN) es una asociación de las organizaciones de estándares nacionales de 18 países de la Unión Europea y de la Asociación Europea de Libre Comercio. La principal tarea del CEN es preparar y emitir normas europeas (EN), definido como el conjunto de especificaciones técnicas establecidas y aprobadas en colaboración con las partes interesadas en los diferentes países del CEN. La identificación de las normas europeas en cada país miembro se inicia con las letras de referencia del respectivo país, ejemplo:

- EN: (Approved European standard) Norma Europea: "S 355 J2 G3 Z35"
- BS: (British Standard) BSI Reino Unido: "BS 40D"
- DIN: DIN Alemania: "St 37-3N"
- NF: AFNOR de Francia: "NF A E24-4"

3

3.0 PERFIL TIPO EUROPEO - CALIDADES DE ACERO

CALIDADES DE ACERO UTILIZADO PARA FABRICACIÓN DE PERFILES EUROPEOS (HE, HD, HL, HP, IPE, IPN, UPN, UPE, L)																		
CALIDADES MÁS COMUNES	COMPOSICIÓN QUÍMICA														PROPIEDADES MECÁNICAS			
	L	C	MN	P	S	Si	CU	Ni	Cr	Mo	Nb	V	CE	LÍMITE ELÁSTICO	RESISTENCIA A LA TRACCIÓN		% ALARGA	
EN 10025:1990		(x100)	(x100)	(x100)	(x100)	(x100)	(x100)	(x100)	(x100)	(x100)	(x100)	(x100)	(x100)					
S235JRG2	MIN	17												20Kg/mm2	195MPa	35Kg/mm2	340MPa	22
	MAX	20	140	4.5	4.5			0.9					38	24Kg/mm2	235MPa	48Kg/mm2	470MPa	26
S235JO	MIN													20Kg/mm2	195MPa	35Kg/mm2	340MPa	22
	MAX	17	140	4	4			0.9					38	24Kg/mm2	235MPa	48Kg/mm2	470MPa	26
S235JRG3/4	MIN													20Kg/mm2	195MPa	35Kg/mm2	340MPa	22
	MAX	17	140	3.5	3.5								38	24Kg/mm2	235MPa	48Kg/mm2	470MPa	26
S275JR	MIN													22Kg/mm2	225MPa	41Kg/mm2	400MPa	18
	MAX	22	150	4.5	4.5			0.9					42	28Kg/mm2	275MPa	55Kg/mm2	540MPa	22
S275JO	MIN													22Kg/mm2	225MPa	41Kg/mm2	400MPa	18
	MAX	18	150	4	4			0.9					42	28Kg/mm2	275MPa	55Kg/mm2	540MPa	22
S275J2G3/4	MIN													22Kg/mm2	225MPa	41Kg/mm2	400MPa	18
	MAX	18	150	3.5	3.5								42	28Kg/mm2	275MPa	55Kg/mm2	540MPa	22
S355JR	MIN													30Kg/mm2	295MPa	48Kg/mm2	470MPa	18
	MAX	24	160	4.5	4.5	55		0.9					47	36Kg/mm2	355MPa	65Kg/mm2	630MPa	22
S355JO	MIN													30Kg/mm2	295MPa	48Kg/mm2	470MPa	18
	MAX	22	160	4	4	55		0.9					47	36Kg/mm2	355MPa	65Kg/mm2	630MPa	22
S355J2G3/G4	MIN													30Kg/mm2	295MPa	48Kg/mm2	470MPa	18
	MAX	22	160	3.5	3.5	55							47	36Kg/mm2	355MPa	65Kg/mm2	630MPa	22
S355K2G3/G4	MIN													30Kg/mm2	295MPa	48Kg/mm2	470MPa	18
	MAX	22	160	3.5	3.5	55							47	36Kg/mm2	355MPa	65Kg/mm2	630MPa	22

3

3.1 EQUIVALENCIAS ENTRE NORMAS DE CALIDAD

EN10025 (93)		DIN17100 (87)	UNE 36080 (90)	NF A35-501 (87)	BS4360 (90)	UNI 7070 (84)	SIS (75)	ASTM (96)	JIS G3101 (95)
S185	1.0035	St 33	A 310-0	A 33	-	Fe 320	141300-00	-	-
S235JR	1.0037	St 37-2	AE 235 B	E 24-2	40A	Fe 360 B	141311-00	-	-
S235JRG2	1.0038	RSt 37-2	AE 235 B FN	-	40B	-	141312-00	A570 Grade 36	SS 330
S235JO	1.0114	St 37-3 U	AE 235 C	E 24-3	40C	Fe 360 C	-		
S235J2G3	1.0116	St 37-3 N	AE 235 D	E 24-4	-	Fe 360 D			
S235J2G4	1.0117	-	-	-	40D	-			
S275JR	1.0044	St 44-2	AE 275 B	E 28-2	43B	Fe 430 B	141412-00	A570 Grade 40	SS 400
S275JO	1.0143	St 44-3 U	AE 275 C	E 28-3	43C	Fe 430 C	-		
S275J2G3	1.0144	St 44-3 N	AE 275 D	E 28-4	43D		141414-00		
S275J2G4	1.0145	-	-	-	-		141414-01		
S355JR	1.0045	-	AE 355 B	E 36-2	50B	Fe 510 B	-	A570 Grade 50	-
S355JO	1.0553	St 55-3 U	AE 355 C	E 36-2	50C	Fe 510 C			
S355J2G3	1.0570	St 52-3 N	AE 355 D	-	50D	Fe 510 D			
S355J2G4	1.0577	-	-	-	-	-			
S355K2G3	1.0595			E 36-4	50DD				
S355K2G4	1.0596			-	-				
E295	1.0050			St 50-2	A 490		A 50-2	-	Fe 490
E335	1.0060	St 60-2	A 590	A 60-2	-	Fe 590	141650-00	-	-
E 360	1.0070	St 70-2	A 690	A 70-2	-	Fe 690	141655-00	-	-

3

3.2 TOLERANCIAS DE PERFILES ESTRUCTURALES: IPN, IPE, HE, HD, HP, UB, UC, W.

PROPIEDAD		IPE, HEA, HEB, HEM, HD260, HD320, HP, UB, UC, UBP	IPN	W, HD360, HD400, HP (ASTM)
Norma		EN 10034:1993	EN 10024:1995	ASTM A6 - 98
Altura: h (mm)		$h \leq 180$	$h \leq 200$	$\pm 4/-3$
Anchura del ala: b (mm)		$180 < h \leq 400$	$200 < h \leq 400$	$c \leq h+6$
		$400 < h \leq 700$	$400 < h$	
		$h > 700$		
Espesor del ala s (mm)	$b \leq 110$	$b \leq 75$	$+6/-5$	
	$110 < b \leq 210$	$75 < b \leq 100$		
	$210 < b \leq 325$	$100 < b \leq 125$		
	$b > 325$	$400 < b$		
	$s < 7$	$s < 7$	Limitado por la tolerancia en masa	
	$7 \leq s < 10$	$7 < s \leq 10$		
Espesor del ala t (mm)	$10 \leq s < 20$	$10 < s$		
	$20 \leq s < 40$			
	$40 \leq s < 60$			
	$s \geq 60$			
	$t < 6.5$	$t \leq 7$	Limitado por la tolerancia en masa	
	$6.5 \leq t < 10$	$7 < t \leq 10$		
Falta de paralelismo k + k' (mm)	$10 \leq t < 20$	$10 < t \leq 20$		
	$20 \leq t < 30$	$20 < t$		
	$30 \leq t < 40$			
	$40 \leq t < 60$			
	$t \geq 60$			
	$b \leq 110$	$b \leq 100$		
Asimetría del ala: e (mm) donde $e = (b_1 - b_2)/2$	$b > 110$	$100 < b$		
	$t < 40$	$b \leq 100$		
	$b \leq 110$	$100 < b$		
	$110 < b \leq 325$			
	$b > 325$			
	$t \geq 40$			
Rectitud q_{xx} y q_{yy} (mm)	$80 < h \leq 180$	$80n < h \leq 180$		
	$180 < h \leq 360$	$180 < h \leq 360$		
	$h > 360$	$360 < h$		
Longitud L (mm)	$0.0030 L$	$0.0015 L$		
	$0.001 L$	$0.001 L$		
Masa M(%)	$-0/+100$ ¹⁾	$-0/+100$ ¹⁾		
	± 50	± 50		
	± 40	± 40		

1) Si se solicitan longitudes mínimas.

2) $b < 150$: $q_{yy} \leq 0.002 L$. W200x200, W250x250, W310x310, W360x370, W360x410 si se especifica:
 $L \leq 14m$: 0.001 (max. 10mm) $L > 14m$: $10 \cdot 0.001 (L-14000)$

3

3.3 TOLERANCIAS DE PERFILES ESTRUCTURALES: U, UPN, UAP, C.

PROPIEDAD		U, UPN, UAP		C		
		EN 10279:2000		ASTM A6 - 98		
Norma						
Altura: h (mm)						
Anchura del ala: b (mm)						
Espesor del alma: s (mm)						
Espesor del ala: t (mm)						
Radio de redondeo: r3 (mm)						
Falta de paralelismo: k + k' (mm)						
Curvatura del alma: f (mm)						
Rectitud qxx y qyy (mm)			qxx		qyy ≤ 0.002L	
			h ≤ 150	±0.3% de I		
			150 < h ≤ 300	±0.2% de I		
	300 < h		±0.15% de I			
	qyy					
	h ≤ 150		±0.5% de I			
150 < h ≤ 300	±0.3% de I					
300 < h	±0.2% de I					
Longitud: L (mm)	Normal	Todas	-o/+100	-0/+100 1) 3)		
	Alternativo (por acuerdo)	Todas	±50			
Masa por unidad de longitud: M (Kg/m)		h < 125	±6%	±2.5%		
		125 < h	±4%			

1) Si se solicitan longitudes mínimas. 2) Tolerancias en más limitadas por la masa. 3) Tolerancias usuales.

3

3.4 PERFILES EN L Ó ÁNGULOS DE LADOS IGUALES (MILIMÉTRICOS).

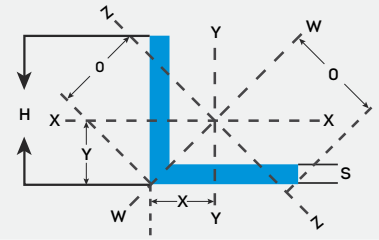

ANGULOS TIPO EUROPEO DE LADOS IGUALES																		
PERFILES EN L	DIMENSIONES Y PROPIEDADES PARA EL DISEÑO																	
	DIMENSIONES				DISTANCIAS DE LOS EJES			AREA	PESO	PROPIEDADES ELASTICAS								
	ALTURA=ALA		RADIOS		DE LOS EJES					EJE X-X = Y-Y			EJE W-W		EJE Z-Z			
DESIGNACIÓN	h	s	r1	r2	x=y	w	z	cm ²	kg/mt	Ix	Sx	rx	Iw	rw	Iz	Sz	rz	
	mm	mm	mm	mm	cm	cm	cm			cm ⁴	cm ³	cm	cm ⁴	cm	cm ⁴	cm ³	cm	
L 3 X 20	20.00	3.00	3.50	2.00	0.60	1.41	0.85	1.12	0.88	0.39	0.28	0.59	0.62	0.74	0.15	0.18	0.37	
L 3 X 25	25.00	3.00	3.50	2.00	0.72	1.77	1.02	1.43	1.12	0.80	0.45	0.75	1.26	0.94	0.33	0.33	0.48	
L 3 X 30	30.00	3.00	3.50	2.50	0.84	2.12	1.18	1.74	1.36	1.40	0.65	0.90	2.23	1.13	0.58	0.49	0.58	
L 3 X 35	35.00	3.00	5.00	2.50	0.96	2.47	1.36	2.04	1.60	2.29	0.90	1.06	3.63	1.34	0.95	0.70	0.68	
L 4 X 25	25.00	4.00	3.50	2.00	0.76	1.77	1.07	1.86	1.46	1.01	0.58	0.74	1.60	0.93	0.43	0.40	0.48	
L 4 X 30	30.00	4.00	5.00	2.50	0.88	2.12	1.24	2.27	1.78	1.80	0.85	0.89	2.85	1.12	0.75	0.61	0.58	
L 4 X 35	35.00	4.00	5.00	2.50	1.00	2.47	1.42	2.67	2.09	2.95	1.18	1.05	4.68	1.33	1.23	0.86	0.68	
L 4 X 40	40.00	4.00	6.00	3.00	1.12	2.83	1.58	3.08	2.42	4.47	1.55	1.21	7.09	1.52	1.86	1.17	0.78	
L 4 X 45	45.00	4.00	7.00	3.50	1.23	3.18	1.75	3.49	2.74	6.43	1.97	1.36	10.20	1.71	2.67	1.55	0.88	
L 4 X 50	50.00	4.00	7.00	3.50	1.36	3.54	1.92	3.89	3.06	8.97	2.46	1.52	14.20	1.91	3.72	1.94	0.98	
L 4 X 75	75.00	4.00	9.00	4.50	1.96	5.30	2.76	5.93	4.65	31.43	5.67	2.30	49.85	2.90	13.01	-	1.48	
L 5 X 40	40.00	5.00	6.00	3.00	1.16	2.83	1.64	3.79	2.97	5.43	1.91	1.20	8.61	1.51	2.25	-	0.77	
L 5 X 50	50.00	5.00	7.00	3.50	1.40	3.54	1.99	4.80	3.77	11.00	3.05	1.52	17.40	1.90	4.54	2.29	0.97	
L 5 X 60	60.00	5.00	8.00	4.00	1.64	4.24	2.32	5.82	4.57	19.40	4.45	1.82	30.70	2.30	8.02	3.45	1.17	
L 5 X 75	75.00	5.00	9.00	4.50	2.01	5.30	2.84	7.34	5.76	38.77	7.06	2.30	61.59	2.90	15.96	-	1.47	
L 6 X 40	40.00	6.00	6.00	3.00	1.20	2.83	1.70	4.48	3.52	6.31	2.26	1.19	9.98	1.49	2.65	1.56	0.77	
L 6 X 50	50.00	6.00	7.00	3.50	1.45	3.54	2.04	5.69	4.47	12.80	3.61	1.50	20.30	1.89	5.33	2.61	0.97	
L 6 X 60	60.00	6.00	8.00	4.00	1.69	4.24	2.39	6.91	5.42	22.80	5.29	1.82	36.20	2.29	9.43	3.95	1.17	
L 6 X 70	70.00	6.00	9.00	4.50	1.93	4.95	2.73	8.13	6.38	36.90	7.27	2.13	58.50	2.68	15.30	5.59	1.37	
L 6 X 75	75.00	6.00	9.00	4.50	2.05	5.30	2.90	8.73	6.85	45.83	8.41	2.29	72.84	2.89	18.82	-	1.47	
L 6 X 100	100.00	6.00	12.00	6.00	2.64	7.07	3.74	11.80	9.26	111.10	11.10	3.07	176.30	3.87	45.80	-	1.97	
L 7 X 50	50.00	7.00	7.00	3.50	1.49	3.54	2.10	6.56	5.15	10.96	3.05	1.51	17.41	1.90	4.52	-	0.97	
L 7 X 65	65.00	7.00	9.00	4.50	1.85	4.60	2.65	8.70	6.83	33.43	7.18	1.96	53.08	2.47	13.78	-	1.26	
L 7 X 75	75.00	7.00	9.00	4.50	2.10	5.30	2.96	10.10	7.93	52.61	9.74	2.28	83.60	2.88	21.62	-	1.46	
L 7 X 100	100.00	7.00	12.00	6.00	2.69	7.07	3.81	13.70	10.70	128.20	17.54	3.06	203.70	3.86	52.72	-	1.96	
L 8 X 50	50.00	8.00	7.00	3.50	1.52	3.54	2.16	7.41	5.82	16.30	4.68	1.48	25.70	1.86	6.87	3.19	0.96	
L 8 X 60	60.00	8.00	8.00	4.00	1.77	4.24	2.50	9.03	7.09	29.20	6.89	1.80	46.20	2.26	12.20	4.86	1.16	
L 8 X 75	75.00	8.00	9.00	4.50	2.14	5.30	3.02	11.40	8.99	59.13	11.03	2.27	93.91	2.86	24.35	-	1.46	
L 8 X 100	100.00	8.00	12.00	6.00	2.74	7.07	3.87	15.50	12.20	145.00	19.90	3.06	230.00	3.85	59.80	15.50	1.96	
L 10 X 75	75.00	10.00	9.00	4.50	2.22	5.30	3.13	14.10	11.10	71.43	13.52	2.25	113.20	2.83	29.68	-	1.45	
L 10 X 100	100.00	10.00	12.00	6.00	2.82	7.07	3.99	19.20	15.00	177.00	24.60	3.04	280.00	3.83	72.90	18.30	1.95	
L 10 X 120	120.00	10.00	13.00	6.50	3.31	8.49	4.69	23.20	18.20	313.00	36.00	3.67	497.00	4.63	129.00	27.50	2.36	
L 10 X 150	150.00	10.00	16.00	8.00	4.03	10.61	5.71	29.30	23.00	624.00	56.91	4.62	992.00	5.82	256.10	-	2.96	
L 12 X 80	80.00	12.00	10.00	5.00	2.41	5.66	3.41	17.90	14.00	102.00	18.20	2.39	161.00	3.00	42.70	12.50	1.55	
L 12 X 100	100.00	12.00	12.00	6.00	2.90	7.07	4.11	22.70	17.80	207.00	29.10	3.02	328.00	3.80	85.70	20.90	1.94	
L 12 X 120	120.00	12.00	13.00	6.50	3.40	8.49	4.80	27.50	21.60	368.00	42.70	3.65	584.00	4.60	152.00	31.50	2.35	
L 12 X 150	150.00	12.00	16.00	8.00	4.12	10.60	5.83	34.80	27.30	737.00	67.70	4.60	1170.00	5.80	303.00	52.00	2.95	
L 15 X 120	120.00	15.00	13.00	6.50	3.51	8.49	4.97	33.90	26.60	444.90	52.43	3.62	705.60	4.56	184.20	-	2.33	
L 15 X 150	150.00	15.00	16.00	8.00	4.25	10.60	6.01	43.00	33.80	898.00	83.50	4.57	1430.00	5.76	370.00	61.60	2.93	
L 15 X 200																		
L 20 X 150	150.00	20.00	16.00	8.00	4.44	10.61	6.28	56.30	44.20	1146.00	108.60	4.51	1817.00	5.68	476.20	-	2.91	
L 20 X 200	200.00	20.00	18.00	9.00	5.68	14.10	8.04	76.30	59.90	2850.00	199.00	6.11	4530.00	7.70	1170.00	146.00	3.92	
L 25 X 200	200.00	25.00	18.00	9.00	5.88	14.14	8.31	94.10	73.90	3446.00	244.00	6.05	5467.00	7.62	1426.00	-	3.89	
L 25 X 250	250.00	25.00	18.00	9.00	7.13	17.68	10.08	119.00	93.50	6986.00	390.90	7.66	11110.00	9.66	2861.00	-	4.90	

3

3.5 PERFILES EN U Ó C ESTÁNDAR EUROPEO - UPN Y PERFIL C SECCIÓN PEQUEÑA.

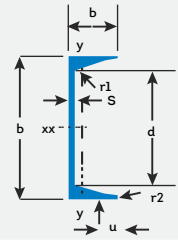

PERFIL C ESTÁNDAR EUROPEO - UPN																
PERFILES UPN		DIMENSIONES Y PROPIEDADES PARA EL DISEÑO														
DESIGNACIÓN	DIMENSIONES							AREA cm ²	PESO kg/mt	PROPIEDADES ELASTICAS						CONS TORS Jt cm ⁴
	ALTURA		ALA		DISTANCIAS					EJE X-X			EJE Y-Y			
	h mm	s mm	b mm	t mm	r1 mm	r2 mm	d mm			Ix cm ⁴	Sx cm ³	rx cm	Iy cm ⁴	Sy cm ³	ry cm	
UPN 80	80.00	6.00	45.00	8.00	8.00	4.00	46.00	11.00	8.64	106.00	26.50	3.10	19.40	6.36	1.33	2.16
UPN 100	100.00	6.00	50.00	8.50	8.50	4.50	64.00	13.50	10.60	206.00	41.20	3.91	29.30	8.49	1.47	2.81
UPN 120	120.00	7.00	55.00	9.00	9.00	4.50	82.00	17.00	13.40	364.00	60.70	4.62	43.20	11.10	1.59	4.15
UPN 140	140.00	7.00	60.00	10.00	10.00	5.00	98.00	20.40	16.00	605.00	86.40	5.45	62.70	14.80	1.75	5.68
UPN 160	160.00	7.50	65.00	10.50	10.50	5.50	115.00	24.00	18.80	925.00	116.00	6.21	85.30	18.30	1.89	7.39
UPN 180	180.00	8.00	70.00	11.00	11.00	5.50	133.00	28.00	22.00	1350.00	150.00	6.95	114.00	22.40	2.02	9.55
UPN 200	200.00	8.50	75.00	11.50	11.50	6.00	151.00	32.20	25.30	1910.00	191.00	7.70	148.00	27.00	2.14	11.90
UPN 220	220.00	9.00	80.00	12.50	12.50	6.50	167.00	37.40	29.40	2690.00	245.00	8.48	197.00	33.60	2.30	16.00
UPN 240	240.00	9.50	85.00	13.00	13.00	6.50	184.00	42.30	33.20	3600.00	300.00	9.22	248.00	39.60	2.42	19.70
UPN 260	260.00	10.00	90.00	14.00	14.00	7.00	200.00	48.30	37.90	4820.00	371.00	9.99	317.00	47.70	2.56	25.50
UPN 280	280.00	10.00	95.00	15.00	15.00	7.50	216.00	53.30	41.80	6280.00	448.00	10.90	399.00	57.20	2.74	31.00
UPN 300	300.00	10.00	100.00	16.00	16.00	8.00	232.00	58.80	46.20	8030.00	535.00	11.70	495.00	67.80	2.90	37.40
UPN 320	320.00	14.00	100.00	17.00	17.50	8.75	246.00	75.80	59.50	10870.00	679.00	12.10	597.00	80.60	2.81	66.70
UPN 350	350.00	14.00	100.00	16.00	16.00	8.00	282.00	77.30	60.60	12840.00	734.00	12.90	570.00	75.00	2.70	61.20
UPN 380	380.00	13.50	102.00	16.00	16.00	8.00	313.00	80.40	63.10	15760.00	829.00	14.00	615.00	78.70	2.77	59.10
UPN 400	400.00	14.00	110.00	18.00	18.00	9.00	324.00	91.50	71.80	20350.00	1020.00	14.90	846.00	102.00	3.04	81.60

PERFIL C EUROPEO SECCION PEQUEÑA - U																
PERFILES U		DIMENSIONES Y PROPIEDADES PARA EL DISEÑO														
DESIGNACIÓN	DIMENSIONES							AREA cm ²	PESO kg/ mt	PROPIEDADES ELASTICAS						CONS TORS Jt cm ⁴
	ALTURA		ALA		DISTANCIAS					EJE X-X			EJE Y-Y			
	h mm	s mm	b mm	t mm	r1 mm	r2 mm	d mm			Ix cm ⁴	Sx cm ³	rx cm	Iy cm ⁴	Sy cm ³	ry cm	
U 30 X 15	30.00	4.00	15.00	4.50	4.50	2.00	12.00	2.21	1.74	2.53	1.69	1.07	0.38	0.39	0.42	0.165
U 40 X 20	40.00	5.00	20.00	5.50	5.00	2.50	18.00	3.66	2.87	7.58	3.79	1.44	1.14	0.86	0.56	0.363
U 40 X 35	40.00	5.00	35.00	7.00	7.00	3.50	11.00	6.21	4.87	14.10	7.05	1.50	6.68	3.08	1.04	1.00
U 50 X 25	50.00	5.00	25.00	6.00	6.00	3.00	25.00	4.92	3.86	16.80	6.73	1.85	2.49	1.48	0.71	0.878
U 50 X 38	50.00	5.00	38.00	7.00	7.00	3.50	20.00	7.12	5.59	26.40	10.60	1.92	9.12	3.75	1.13	1.12
U 60 X 30	60.00	6.00	30.00	6.00	6.00	3.00	35.00	6.46	5.07	31.60	10.50	2.21	4.51	2.16	0.84	0.939
U 65 X 42	65.00	5.50	42.00	7.50	7.50	4.00	33.00	9.03	7.09	57.50	17.70	2.52	14.10	5.07	1.25	1.61
U 70 X 40	70.00	6.00	40.00	6.50	6.50	3.25	42.00	8.62	6.77	61.80	17.60	2.68	13.00	4.85	1.22	

3

3.6 PERFILES C DE ALAS PARALELAS UPE, ESPAÑA Y POLONIA.

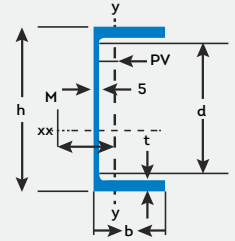

PERFIL C ALAS PARALELAS - UPE - ESPAÑA															
PERFILES UPE	DIMENSIONES Y PROPIEDADES PARA EL DISEÑO														
	DIMENSIONES					AREA	PESO	PROPIEDADES ELASTICAS							CONS TORS
	ALTURA		ALA					EJE X-X			EJE Y-Y				
	h	s	b	t	d	Ix	Sx	rx	Iy	Sy	ry	Jt			
mm	mm	mm	mm	mm	cm ⁴	cm ³	cm	cm ⁴	cm ³	cm	cm ⁴				
UPE80	80.00	4.00	50.00	7.00	66.00	10.10	7.90	107.00	26.80	3.26	25.40	7.98	1.59		
UPE 100	100.00	4.50	55.00	7.50	85.00	12.50	9.82	207.00	41.40	4.07	38.20	10.60	1.75		
UPE 120	120.00	5.00	60.00	8.00	104.00	15.40	12.10	364.00	60.60	4.86	55.40	13.80	1.90		
UPE 140	140.00	5.00	65.00	9.00	122.00	18.40	14.50	599.00	85.60	5.71	78.70	18.20	2.07		
UPE 160	160.00	5.50	70.00	9.50	141.00	21.70	17.00	911.00	114.00	6.48	107.00	22.60	2.22		
UPE 180	180.00	5.50	75.00	10.50	159.00	25.10	19.70	1.353.00	150.00	7.34	144.00	28.60	2.39		
UPE 200	200.00	6.00	80.00	11.00	178.00	29.00	22.80	1.909.00	191.00	8.11	187.00	34.40	2.54		
UPE 220	220.00	6.50	85.00	12.00	196.00	33.90	26.60	2.682.00	244.00	8.90	246.00	42.50	2.70		
UPE 240	240.00	7.00	90.00	12.50	217.00	38.50	30.20	3.599.00	300.00	9.67	311.00	50.10	2.84		
UPE 270	270.00	7.50	95.00	13.50	243.00	44.80	35.20	5.255.00	389.00	10.80	401.00	60.70	2.99		
UPE 300	300.00	9.50	100.00	15.00	270.00	56.60	44.40	7.823.00	522.00	11.80	538.00	75.60	3.08		
UPE 330	330.00	11.00	105.00	16.00	298.00	67.80	53.20	11.008.00	667.00	12.70	681.00	89.70	3.17		
UPE 360	360.00	12.00	110.00	17.00	326.00	77.90	61.20	14.825.00	824.00	13.80	844.00	105.00	3.29		
UPE 400	400.00	13.50	115.00	18.00	364.00	91.90	72.20	20.981.00	1.049.00	15.10	1.045.00	123.00	3.37		

PERFIL C ALAS PARALELAS - UPE																	
PERFILES UPE	DIMENSIONES Y PROPIEDADES PARA EL DISEÑO																
	DIMENSIONES							AREA	PESO	PROPIEDADES ELASTICAS							CONS TORS
	ALTURA		ALA		DISTANCIAS					EJE X-X			EJE Y-Y				
	h	s	b	t	r1	r2	d	Ix	Sx	rx	Iy	Sy	ry	Jt			
mm	mm	mm	mm	mm	mm	mm	cm ²	kg/mt	cm ⁴	cm ³	cm	cm ⁴	cm ³	cm	cm ⁴		
UPE 80	80.00	4.50	40.00	7.40	5.50	2.50	9.00	7.10	89.00	22.40		12.80	4.75				
UPE 100	100.00	4.50	46.00	7.60	7.00	3.00	10.90	8.60	174.00	34.80		20.40	6.46				
UPE 120	120.00	4.80	52.00	7.80	7.50	3.00	13.30	10.40	304.00	50.60		31.20	8.52				
UPE 140	140.00	4.90	58.00	8.10	8.00	3.00	15.60	12.30	491.00	70.20		45.40	11.00				
UPE 160	160.00	5.00	64.00	8.40	8.50	3.50	18.10	14.20	747.00	93.40		63.30	13.80				
UPE 180	180.00	5.10	70.00	8.70	9.00	3.50	20.70	16.30	1.090.00	121.00		86.00	17.00				
UPE 200	200.00	5.20	76.00	9.00	9.50	4.00	23.40	18.40	1.520.00	152.00		113.00	20.50				
UPE 240	240.00	5.60	90.00	10.00	10.50	4.00	30.60	24.00	2.900.00	242.00		208.00	31.60				
UPE 270	270.00	6.00	95.00	10.50	11.00	4.50	35.20	27.70	4.160.00	308.00		262.00	37.30				
UPE 300	300.00	6.50	100.00	11.00	12.00	5.00	40.50	31.80	5.810.00	387.00		327.00	43.60				
UPE 400	400.00	8.00	115.00	13.50	15.00	6.00	61.50	48.30	15.220.00	761.00		642.00	73.40				

3

3.7 PERFIL I ESTÁNDAR EUROPEO - IPN.

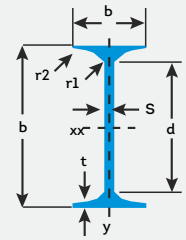

PERFIL I ESTANDAR EUROPEO - IPN																		
PERFILES IPN		Dimensiones y propiedades para el diseño																
DESIGNACIÓN	DIMENSIONES							AREA	PESO	PROPIEDADES ELASTICAS						MODULO PLASTICO		CONS TORS
	ALTURA		ALA		DISTANCIAS					EJE X-X			EJE Y-Y			Zx	Zy	
	h	s	b	t	r1	r2	d			Ix	Sx	rx	Iy	Sy	ry	cm3	cm3	
	mm	mm	mm	mm	mm	mm	mm	cm2	kg/mt	cm4	cm3	cm	cm4	cm3	cm	cm3	cm3	cm4
IPN 80	80	3.90	42.00	5.90	3.90	2.30	59.00	7.57	5.94	77.80	19.50	3.20	6.29	3.00	0.91	22.80	4.99	0.87
IPN 100	100	4.50	50.00	6.80	4.50	2.70	75.00	10.60	8.34	171.00	34.20	4.01	12.20	4.88	1.07	39.80	8.09	1.60
IPN 120	120	5.10	58.00	7.70	5.10	3.10	92.00	14.20	11.10	328.00	54.70	4.81	21.50	7.41	1.23	63.60	12.30	2.71
IPN 140	140	5.70	66.00	8.60	5.70	3.40	109.00	18.20	14.30	573.00	81.90	5.61	35.20	10.70	1.40	95.40	17.90	4.32
IPN 160	160	6.30	74.00	9.50	6.30	3.80	125.00	22.80	17.90	935.00	117.00	6.40	54.70	14.80	1.55	136.00	24.90	6.57
IPN 180	180	6.90	82.00	10.40	6.90	4.10	142.00	27.90	21.90	1.450.00	161.00	7.20	81.30	19.80	1.71	187.00	33.20	9.58
IPN 200	200	7.50	90.00	11.30	7.50	4.50	159.00	33.40	26.20	2.140.00	214.00	8.00	117.00	26.00	1.87	250.00	43.50	13.50
IPN 220	220	8.10	98.00	12.20	8.10	4.90	176.00	39.50	31.10	3.060.00	278.00	8.80	162.00	33.10	2.02	324.00	55.70	18.60
IPN 240	240	8.70	106.00	13.10	8.70	5.20	192.00	46.10	36.20	4.250.00	354.00	9.59	221.00	41.70	2.20	412.00	70.00	25.00
IPN 260	260	9.40	113.00	14.10	9.40	5.60	208.00	53.30	41.90	5.740.00	442.00	10.40	288.00	51.00	2.32	514.00	85.90	33.50
IPN 280	280	10.10	119.00	15.20	10.10	6.10	225.00	61.00	47.90	7.590.00	542.00	11.10	364.00	61.20	2.45	632.00	103.00	44.20
IPN 300	300	10.80	125.00	16.20	10.80	6.50	241.00	69.00	54.20	9.800.00	653.00	11.90	451.00	72.20	2.56	762.00	121.00	56.80
IPN 320	320	11.50	131.00	17.30	11.50	6.90	258.00	77.70	61.00	12.510.00	782.00	12.70	555.00	84.70	2.67	914.00	143.00	72.50
IPN 340	340	12.20	137.00	18.30	12.20	7.30	274.00	86.70	68.00	15.700.00	923.00	13.50	674.00	98.40	2.80	1.080.00	166.00	90.40
IPN 360	360	13.00	143.00	19.50	13.00	7.80	290.00	97.00	76.10	19.610.00	1.090.00	14.20	818.00	114.00	2.90	1.276.00	194.00	115.00
IPN 380	380	13.70	149.00	20.50	13.70	8.20	306.00	107.00	84.00	24.010.00	1.260.00	15.00	975.00	131.00	3.02	1.482.00	221.00	141.00
IPN 400	400	14.40	155.00	21.60	14.40	8.60	323.00	118.00	92.40	29.210.00	1.460.00	15.70	1.160.00	149.00	3.13	1.714.00	253.00	170.00
IPN 450	450	16.20	170.00	24.30	16.20	9.70	363.00	147.00	115.00	45.850.00	2.040.00	17.70	1.730.00	203.00	3.43	2.400.00	345.00	267.00
IPN 500	500	18.00	185.00	27.00	18.00	10.80	404.00	179.00	141.00	68.740.00	2.750.00	19.60	2.480.00	268.00	3.72	3.240.00	456.00	402.00
IPN 550	550	19.00	200.00	30.00	19.00	11.90	445.00	212.00	166.00	99.180.00	3.610.00	21.60	3.490.00	349.00	4.02	4.240.00	592.00	544.00
IPN 600	600	21.60	215.00	32.40	21.60	13.00	485.00	254.00	199.00	139.000.00	4.630.00	23.40	4.670.00	434.00	4.30			

3

3.8 PERFIL I LIVIANO DE ALAS PARALELAS - IPE

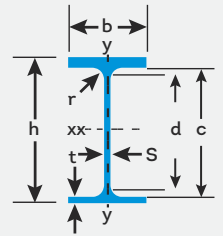

PERFIL I LIVIANO DE ALAS PARALELAS - IPE																		
PERFILES IPE	Dimensiones y propiedades para el diseño																	
	DIMENSIONES								PROPIEDADES ELASTICAS							MODULO PLASTICO		CONS TORS
	ALTURA		ALA		DISTANCIAS		AREA	PESO	EJE X-X			EJE Y-Y			Zx	Zy	Jt	
DESIGNACION	h	s	b	t	r	c	d		kg/mt	Ix	Sx	rx	Iy	Sy	ry	cm3	cm3	cm4
	mm	mm	mm	mm	mm	mm	mm	cm2		cm4	cm3	cm	cm4	cm3	cm			
IPE 80	80.00	3.80	46.00	5.20	5.00	69.60	59.60	7.64	6.00	80.10	20.00	3.24	8.50	3.70	1.05	23.20	5.80	0.70
IPE 100	100.00	4.10	55.00	5.70	7.00	88.60	74.60	10.30	8.10	171.00	34.20	4.07	15.90	5.80	1.24	39.40	9.10	1.20
IPE A 120	117.60	3.80	64.00	5.10	7.00	107.40	93.40	11.00	8.66	257.00	43.80	4.83	22.40	7.00	1.42	49.90	11.00	1.04
IPE 120	120.00	4.40	64.00	6.30	7.00	107.40	93.40	13.20	10.40	318.00	53.00	4.90	27.70	8.60	1.45	60.70	13.60	1.74
IPE A 140	137.40	3.80	73.00	5.60	7.00	126.20	112.20	13.40	10.50	435.00	63.30	5.70	36.40	10.00	1.65	71.60	15.50	1.36
IPE 140	140.00	4.70	73.00	6.90	7.00	126.20	112.20	16.40	12.90	541.00	77.30	5.74	44.90	12.30	1.65	88.30	19.20	2.45
IPE R 140	142.00	5.30	72.00	7.80	7.00	126.40	112.40	18.40	14.40	611.00	86.10	5.77	48.80	13.50	1.63	99.10	21.30	3.43
IPE A 160	157.00	4.00	82.00	5.90	9.00	145.20	127.20	16.20	12.70	689.00	87.80	6.53	54.40	13.30	1.83	99.10	20.70	1.96
IPE 160	160.00	5.00	82.00	7.40	9.00	145.20	127.20	20.10	15.80	869.00	109.00	6.58	68.30	16.70	1.84	124.00	26.10	3.60
IPE R 160	162.00	5.60	81.00	8.50	9.00	145.00	127.00	22.60	17.70	989.00	122.00	6.62	75.70	18.70	1.83	140.00	29.40	5.13
IPE A 180	177.00	4.30	91.00	6.50	9.00	164.00	146.00	19.60	15.40	1063.00	120.00	7.37	81.90	18.00	2.05	135.00	28.00	2.70
IPE 180	180.00	5.30	91.00	8.00	9.00	164.00	146.00	23.90	18.80	1317.00	146.00	7.42	101.00	22.20	2.05	166.00	34.60	4.79
IPE O 180	182.00	6.00	92.00	9.00	9.00	164.00	146.00	27.10	21.30	1505.00	165.00	7.45	117.00	25.50	2.08	189.00	39.90	6.76
IPE R 180	183.00	6.40	89.00	9.50	9.00	164.00	146.00	28.10	22.10	1554.00	170.00	7.44	112.00	25.20	2.00	195.00	39.70	7.78
IPE A 200	197.00	4.50	100.00	7.00	12.00	183.00	159.00	23.50	18.40	1591.00	162.00	8.23	117.00	23.40	2.23	182.00	36.50	4.11
IPE 200	200.00	5.60	100.00	8.50	12.00	183.00	159.00	28.50	22.40	1943.00	194.00	8.26	142.00	28.50	2.24	221.00	44.60	6.98
IPE O 200	202.00	6.20	102.00	9.50	12.00	183.00	159.00	32.00	25.10	2211.00	219.00	8.32	169.00	33.10	2.30	249.00	51.90	9.45
IPE R 200	204.00	6.60	98.00	10.50	12.00	183.00	159.00	33.90	26.60	2363.00	232.00	8.35	166.00	33.80	2.21	265.00	53.20	11.70
IPE A 220	217.00	5.00	110.00	7.70	12.00	201.60	177.60	28.30	22.20	2317.00	214.00	9.05	171.00	31.20	2.46	240.00	48.50	5.69
IPE 220	220.00	5.90	110.00	9.20	12.00	201.60	177.60	33.40	26.20	2772.00	252.00	9.11	205.00	37.30	2.48	285.00	58.10	9.07
IPE O 220	222.00	6.60	112.00	10.20	12.00	201.60	177.60	37.40	29.40	3134.00	282.00	9.16	240.00	42.80	2.53	321.00	66.90	12.30
IPE R 220	225.00	6.70	108.00	11.80	12.00	201.40	177.40	40.20	31.60	3474.00	309.00	9.29	249.00	46.10	2.49	352.00	71.80	16.20
IPE A 240	237.00	5.20	120.00	8.30	15.00	220.40	190.40	33.30	26.20	3290.00	278.00	9.94	240.00	40.00	2.68	312.00	62.40	8.35
IPE 240	240.00	6.20	120.00	9.80	15.00	220.40	190.40	39.10	30.70	3892.00	324.00	9.97	284.00	47.30	2.69	367.00	73.90	12.90
IPE O 240	242.00	7.00	122.00	10.80	15.00	220.40	190.40	43.70	34.30	4369.00	361.00	10.00	329.00	53.90	2.74	410.00	84.40	17.20
IPE R 240	245.00	7.50	118.00	12.30	15.00	220.40	190.40	47.50	37.30	4823.00	394.00	10.10	339.00	57.40	2.67	449.00	90.10	22.70
IPE A 270	267.00	5.50	135.00	8.70	15.00	249.60	219.60	39.10	30.70	4917.00	368.00	11.20	358.00	53.00	3.02	412.00	82.30	10.30
IPE 270	270.00	6.60	135.00	10.20	15.00	249.60	219.60	45.90	36.10	5790.00	429.00	11.20	420.00	62.20	3.02	484.00	97.00	15.90
IPE O 270	274.00	7.50	136.00	12.20	15.00	249.60	219.60	53.80	42.30	6947.00	507.00	11.40	513.00	75.50	3.09	575.00	118.00	24.90
IPE R 270	276.00	7.70	133.00	13.10	15.00	249.80	219.80	56.00	44.00	7312.00	530.00	11.40	516.00	77.60	3.03	602.00	121.00	28.80
IPE A 300	297.00	6.10	150.00	9.20	15.00	278.60	248.60	46.50	36.50	7173.00	483.00	12.40	519.00	69.20	3.34	542.00	107.00	13.40
IPE 300	300.00	7.10	150.00	10.70	15.00	278.60	248.60	53.80	42.20	8356.00	557.00	12.50	604.00	80.50	3.35	628.00	125.00	20.10
IPE O 300	304.00	8.00	152.00	12.70	15.00	278.60	248.60	62.80	49.30	9994.00	658.00	12.60	746.00	98.10	3.45	744.00	153.00	31.10
IPE R 300	306.00	8.50	147.00	13.70	15.00	278.60	248.60	65.90	51.70	10500.00	686.00	12.60	728.00	99.00	3.32	780.00	155.00	37.10

3

3.8 PERFIL I LIVIANO DE ALAS PARALELAS - IPE

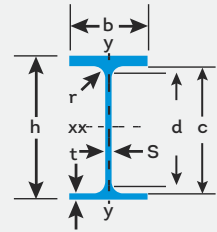

PERFIL I LIVIANO DE ALAS PARALELAS - IPE																		
PERFILES IPE	Dimensiones y propiedades para el diseño																	
	DESIGNACIÓN	DIMENSIONES						AREA	PESO	PROPIEDADES ELASTICAS						MODULO PLASTICO		CONS TORS
		ALTURA		ALA		DISTANCIAS				EJE X-X			EJE Y-Y			Zx	Zy	Jt
		h	s	b	t	r	c			d	Ix	Sx	rx	Iy	Sy	ry	cm3	cm3
mm	mm	mm	mm	mm	mm	mm	cm2	kg/mt	cm4	cm3	cm	cm4	cm3	cm	cm3	cm3	cm4	
IPE A 330	327.00	6.50	160.00	10.00	18.00	307.00	271.00	54.70	43.00	10.230.00	626.00	13.70	685.00	85.60	3.54	702.00	133.00	19.60
IPE 330	330.00	7.50	160.00	11.50	18.00	307.00	271.00	62.60	49.10	11.770.00	713.00	13.70	788.00	98.50	3.55	804.00	154.00	28.10
IPE O 330	334.00	8.50	162.00	13.50	18.00	307.00	271.00	72.60	57.00	13.910.00	833.00	13.80	960.00	119.00	3.64	943.00	185.00	42.20
IPE R 330	336.00	9.20	158.00	14.50	18.00	307.00	271.00	76.80	60.30	14.690.00	874.00	13.80	958.00	121.00	3.53	995.00	190.00	50.80
IPE A 360	357.60	6.60	170.00	11.50	18.00	334.60	298.60	64.00	50.20	14.520.00	812.00	15.10	944.00	111.00	3.84	907.00	172.00	26.50
IPE 360	360.00	8.00	170.00	12.70	18.00	334.60	298.60	72.70	57.10	16.270.00	904.00	15.00	1.043.00	123.00	3.79	1.019.00	191.00	37.30
IPE O 360	364.00	9.20	172.00	14.70	18.00	334.60	298.60	84.10	66.00	19.050.00	1.047.00	15.00	1.251.00	145.00	3.86	1.186.00	227.00	55.80
IPE R 360	366.00	9.90	168.00	16.00	18.00	334.00	298.00	89.60	70.30	20.290.00	1.109.00	15.00	1.270.00	151.00	3.76	1.262.00	236.00	68.80
IPE A 400	397.00	7.00	180.00	12.00	21.00	373.00	331.00	73.10	57.40	20.290.00	1.022.00	16.70	1.171.00	130.00	4.00	1.144.00	202.00	34.80
IPE 400	400.00	8.60	180.00	13.50	21.00	373.00	331.00	84.50	66.30	23.130.00	1.156.00	16.50	1.318.00	146.00	3.95	1.307.00	229.00	51.10
IPE O 400	404.00	9.70	182.00	15.50	21.00	373.00	331.00	96.40	75.70	26.750.00	1.324.00	16.70	1.564.00	172.00	4.03	1.502.00	269.00	73.10
IPE R 400	407.00	10.60	178.00	17.00	21.00	373.00	331.00	104.00	81.50	28.860.00	1.418.00	16.70	1.606.00	180.00	3.93	1.618.00	284.00	92.40
IPE V 400	408.00	10.60	182.00	17.50	21.00	373.00	331.00	107.00	84.00	30.140.00	1.477.00	16.80	1.766.00	194.00	4.06	1.681.00	304.00	99.00
IPE A 450	447.00	7.60	190.00	13.10	21.00	420.80	378.80	85.50	67.20	29.760.00	1.331.00	18.70	1.502.00	158.00	4.19	1.494.00	246.00	45.70
IPE 450	450.00	9.40	190.00	14.60	21.00	420.80	378.80	98.80	77.60	33.740.00	1.500.00	18.50	1.676.00	176.00	4.12	1.702.00	276.00	66.90
IPE O 450	456.00	11.00	192.00	17.60	21.00	420.80	378.80	118.00	92.40	40.920.00	1.795.00	18.60	2.085.00	217.00	4.21	2.046.00	341.00	109.00
IPE R 450	458.00	11.30	188.00	18.60	21.00	420.80	378.80	121.00	95.20	42.400.00	1.851.00	18.70	2.070.00	220.00	4.13	2.115.00	346.00	122.00
IPE V 450	460.00	12.40	194.00	19.60	21.00	420.80	378.80	132.00	104.00	46.200.00	2.009.00	18.70	2.397.00	247.00	4.26	2.301.00	389.00	150.00
IPE A 500	497.00	8.40	200.00	14.50	21.00	468.00	426.00	101.00	79.40	42.930.00	1.728.00	20.60	1.939.00	194.00	4.38	1.946.00	302.00	62.80
IPE 500	500.00	10.20	200.00	16.00	21.00	468.00	426.00	116.00	90.70	48.200.00	1.928.00	20.40	2.142.00	214.00	4.31	2.194.00	336.00	89.30
IPE O 500	506.00	12.00	202.00	19.00	21.00	468.00	426.00	137.00	107.00	57.780.00	2.284.00	20.60	2.622.00	260.00	4.38	2.613.00	409.00	143.00
IPE R 500	508.00	12.60	198.00	20.00	21.00	468.00	426.00	142.00	111.00	59.930.00	2.360.00	20.50	2.600.00	263.00	4.28	2.709.00	415.00	163.00
IPE V 500	514.00	14.20	204.00	23.00	21.00	468.00	426.00	164.00	129.00	70.720.00	2.752.00	20.80	3.271.00	321.00	4.47	3.168.00	507.00	243.00
IPE A 550	547.00	9.00	210.00	15.70	24.00	515.60	467.60	117.00	92.10	59.980.00	2.193.00	22.60	2.432.00	232.00	4.55	2.475.00	362.00	86.50
IPE 550	550.00	11.10	210.00	17.20	24.00	515.60	467.60	134.00	106.00	67.120.00	2.441.00	22.30	2.668.00	254.00	4.45	2.787.00	401.00	123.00
IPE O 550	556.00	12.70	212.00	20.20	24.00	515.60	467.60	156.00	123.00	79.160.00	2.847.00	22.50	3.224.00	304.00	4.55	3.263.00	481.00	188.00
IPE R 550	560.00	14.00	210.00	22.20	24.00	515.60	467.60	170.00	134.00	86.600.00	3.093.00	22.50	3.447.00	328.00	4.50	3.562.00	521.00	243.00
IPE V 550	566.00	17.10	216.00	25.20	24.00	515.60	467.60	202.00	159.00	102.300.00	3.616.00	22.50	4.265.00	395.00	4.60	4.205.00	632.00	380.00
IPE A 600	597.00	9.80	220.00	17.50	24.00	562.00	514.00	137.00	108.00	82.920.00	2.778.00	24.60	3.116.00	283.00	4.77	3.141.00	442.00	119.00
IPE 600	600.00	12.00	220.00	19.00	24.00	562.00	514.00	156.00	122.00	92.080.00	3.069.00	24.30	3.387.00	308.00	4.66	3.512.00	486.00	165.00
IPE O 600	610.00	15.00	224.00	24.00	24.00	562.00	514.00	197.00	154.00	118.300.00	3.879.00	24.50	4.521.00	404.00	4.79	4.471.00	640.00	318.00
IPE R 600	608.00	14.00	218.00	23.00	24.00	562.00	514.00	184.00	144.00	110.300.00	3.628.00	24.50	3.993.00	366.00	4.66	4.175.00	580.00	271.00
IPE V 600	613.00	18.00	228.00	28.00	24.00	562.00	514.00	234.00	184.00	141.600.00	4.582.00	24.60	5.570.00	489.00	4.88	5.324.00	780.00	512.00
IPE 750 X 137	758.00	11.50	263.00	17.00	17.00	719.00	685.00	175.00	137.00	159.900.00	4.246.00	30.30	5.166.00	393.00	5.44	4.865.00	614.00	137.00
IPE 750 X 147	753.00	13.20	265.00	17.00	17.00	719.00	685.00	187.00	147.00	166.100.00	4.411.00	29.80	5.289.00	399.00	5.31	5.110.00	631.00	162.00
IPE 750 X 161	758.00	13.80	266.00	19.30	17.00	719.40	685.40	204.00	161.00	186.100.00	4.909.00	30.20	6.073.00	457.00	5.45	5.666.00	720.00	212.00
IPE 750 X 173	762.00	14.40	267.00	21.60	17.00	718.80	684.80	221.00	173.00	205.800.00	5.402.00	30.50	6.873.00	515.00	5.57	6.218.00	810.00	274.00
IPE 750 X 185	766.00	14.90	267.00	23.60	17.00	718.80	684.80	236.00	185.00	223.000.00	5.821.00	30.80	7.510.00	563.00	5.65	6.691.00	884.00	337.00
IPE 750 X 196	770.00	15.60	268.00	25.40	17.00	719.20	685.20	251.00	196.00	240.300.00	6.241.00	31.00	8.175.00	610.00	5.71	7.174.00	959.00	409.00
IPE 750 X 210	775.00	16.00	268.00	28.00	17.00	719.00	685.00	268.00	210.00	262.200.00	6.765.00	31.30	9.011.00	672.00	5.80	7.762.00	1.054.00	514.00
IPE 750 X 222	778.00	17.00	269.00	29.50	17.00	719.00	685.00	283.00	222.00	278.200.00	7.152.00	31.30	9.604.00	714.00	5.82	8.225.00	1.122.00	605.00

3

3.9 PERFIL H EUROPEO DE ALA ANCHA - HE

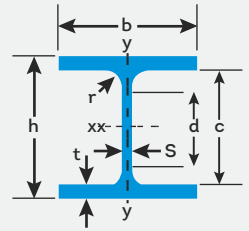

PERFIL H EUROPEO DE ALA ANCHA - HE																			
DIMENSIONES Y PROPIEDADES PARA EL DISEÑO																			
PERFILES HE	DIMENSIONES							AREA	PESO	PROPIEDADES ELASTICAS						MODULO PLASTICO		CONS TORS	
	DESIGNACIÓN	ALTAURA		ALA			DISTANCIAS			EJE X-X			EJE Y-Y			Zx	Zy		
		h	s	b	t	r	c			d	Ix	Sx	rx	Iy	Sy	ry	cm3		cm3
mm	mm	mm	mm	mm	mm	mm	mm	cm2	kg/mt	cm4	cm3	cm	cm4	cm3	cm	cm3	cm3	cm4	
HEA A 100	91.0	4.2	100.0	5.5	12.0	80.0	56.0	15.6	12.2	237.0	52.0	3.89	92.10	18.40	2.43	58.40	28.40	2.51	
HEA 100	96.0	5.0	100.0	8.0	12.0	80.0	56.0	21.2	16.7	349.0	72.8	4.06	134.00	26.80	2.51	83.00	41.10	5.24	
DIL 100	100.0	5.0	100.0	10.0	12.0	80.0	56.0	25.2	19.8	445.0	89.1	4.20	167.00	33.40	2.57	103.00	51.10	8.40	
HEB 100	100.0	6.0	100.0	10.0	12.0	80.0	56.0	26.0	20.4	450.0	89.9	4.16	167.00	33.50	2.53	104.00	51.40	9.25	
HEM 100	120.0	12.0	106.0	20.0	12.0	80.0	56.0	53.2	41.8	1143.0	190.0	4.63	399.00	75.30	2.74	236.00	116.00	68.20	
HEA A 120	109.0	4.2	120.0	5.5	12.0	98.0	74.0	18.6	14.6	413.0	75.8	4.72	159.00	26.50	2.93	84.10	40.60	2.78	
HEA 120	114.0	5.0	120.0	8.0	12.0	98.0	74.0	25.3	19.9	606.0	106.0	4.89	231.00	38.50	3.02	119.00	58.90	5.99	
DIL 120	120.0	5.0	120.0	11.0	12.0	98.0	74.0	32.5	25.5	853.0	142.0	5.12	317.00	52.90	3.12	162.00	80.50	12.40	
HEB 120	120.0	6.5	120.0	11.0	12.0	98.0	74.0	34.0	26.7	864.0	144.0	5.04	318.00	52.90	3.06	165.00	81.00	13.80	
HEM 120	140.0	12.5	126.0	21.0	12.0	98.0	74.0	66.4	52.1	2.018.0	288.0	5.51	703.00	112.00	3.25	351.00	172.00	91.70	
HEA A 140	128.0	4.3	140.0	6.0	12.0	116.0	92.0	23.0	18.1	719.0	112.0	5.59	275.00	39.30	3.45	124.00	59.90	3.54	
HEA 140	133.0	5.5	140.0	8.5	12.0	116.0	92.0	31.4	24.7	1.033.0	155.0	5.73	389.00	55.60	3.52	173.00	84.80	8.13	
DIL 140	140.0	5.0	140.0	12.0	12.0	116.0	92.0	40.6	31.9	1.483.0	212.0	6.04	549.00	78.50	3.68	239.00	119.00	17.80	
HEB 140	140.0	7.0	140.0	12.0	12.0	116.0	92.0	43.0	33.7	1.509.0	216.0	5.93	550.00	78.50	3.58	245.00	120.00	20.10	
HEM 140	160.0	13.0	146.0	22.0	12.0	116.0	92.0	80.6	63.2	3.291.0	411.0	6.39	1.144.00	157.00	3.77	494.00	241.00	120.00	
HEA A 160	148.0	4.5	160.0	7.0	15.0	134.0	104.0	30.4	23.8	1.283.0	173.0	6.50	479.00	59.80	3.97	190.00	91.40	6.33	
HEA 160	152.0	6.0	160.0	9.0	15.0	134.0	104.0	38.8	30.4	1.673.0	220.0	6.57	616.00	76.90	3.98	245.00	118.00	12.20	
DIL 160	160.0	5.0	160.0	13.0	15.0	134.0	104.0	50.2	39.4	2.432.0	304.0	6.96	888.00	111.00	4.21	340.00	168.00	26.10	
HEB 160	160.0	8.0	160.0	13.0	15.0	134.0	104.0	54.3	42.6	2.492.0	311.0	6.78	889.00	111.00	4.05	354.00	170.00	31.20	
HEM 160	180.0	14.0	166.0	23.0	15.0	134.0	104.0	97.1	76.2	5.098.0	566.0	7.25	1.759.00	212.00	4.26	675.00	325.00	162.00	
HEA A 180	167.0	5.0	180.0	7.5	15.0	152.0	122.0	36.5	28.7	1.967.0	236.0	7.34	730.00	81.10	4.47	258.00	124.00	8.33	
HEA 180	171.0	6.0	180.0	9.5	15.0	152.0	122.0	45.3	35.5	2.510.0	294.0	7.45	925.00	103.00	4.52	325.00	156.00	14.80	
DIL 180	180.0	5.5	180.0	14.0	15.0	152.0	122.0	60.7	47.6	3.743.0	416.0	7.85	1.362.00	151.00	4.74	464.00	229.00	36.10	
HEB 180	180.0	8.5	180.0	14.0	15.0	152.0	122.0	65.3	51.2	3.831.0	426.0	7.66	1.363.00	151.00	4.57	481.00	231.00	42.20	
HEM 180	200.0	14.5	186.0	24.0	15.0	152.0	122.0	113.0	88.9	7.483.0	748.0	8.13	2.580.00	277.00	4.77	883.00	425.00	203.00	
HEA A 200	186.0	5.5	200.0	8.0	18.0	170.0	134.0	44.1	34.6	2.944.0	317.0	8.17	1.068.00	107.00	4.92	347.00	163.00	12.70	
HEA 200	190.0	6.5	200.0	10.0	18.0	170.0	134.0	53.8	42.3	3.692.0	389.0	8.28	1.336.00	134.00	4.98	429.00	204.00	21.00	
DIL 200	200.0	6.0	200.0	15.0	18.0	170.0	134.0	73.0	57.3	5.573.0	557.0	8.74	2.002.00	200.00	5.24	621.00	303.00	50.70	
HEB 200	200.0	9.0	200.0	15.0	18.0	170.0	134.0	78.1	61.3	5.696.0	570.0	8.54	2.003.00	200.00	5.07	643.00	306.00	59.30	
HEM 200	220.0	15.0	206.0	25.0	18.0	170.0	134.0	131.0	103.0	10.640.0	967.0	9.00	3.651.00	354.00	5.27	1.135.00	543.00	259.00	
HEA A 220	205.0	6.0	220.0	8.5	18.0	188.0	152.0	51.5	40.4	4.170.0	407.0	9.00	1.510.00	137.00	5.42	445.00	209.00	15.90	
HEA 220	210.0	7.0	220.0	11.0	18.0	188.0	152.0	64.3	50.5	5.410.0	515.0	9.17	1.955.00	178.00	5.51	568.00	271.00	28.50	
DIL 220	220.0	6.5	220.0	16.0	18.0	188.0	152.0	85.4	67.0	7.925.0	720.0	9.63	2.842.00	258.00	5.77	801.00	391.00	66.80	
HEB 220	220.0	9.5	220.0	16.0	18.0	188.0	152.0	91.0	71.5	8.091.0	736.0	9.43	2.843.00	258.00	5.59	827.00	394.00	76.60	
HEM 220	240.0	15.5	226.0	26.0	18.0	188.0	152.0	149.0	117.0	14.600.0	1.217.0	9.89	5.012.00	444.00	5.79	1.419.00	679.00	315.00	
HEA A 240	224.0	6.5	240.0	9.0	21.0	206.0	164.0	60.4	47.4	5.835.0	521.0	9.83	2.077.00	173.00	5.87	571.00	264.00	23.00	
HEA 240	230.0	7.5	240.0	12.0	21.0	206.0	164.0	76.8	60.3	7.763.0	675.0	10.10	2.769.00	231.00	6.00	745.00	352.00	41.60	
DIL 240	240.0	7.0	240.0	17.0	21.0	206.0	164.0	99.8	78.3	11.040.0	920.0	10.50	3.921.00	327.00	6.27	1.021.00	495.00	89.50	
HEB 240	240.0	10.0	240.0	17.0	21.0	206.0	164.0	106.0	83.2	11.260.0	938.0	10.30	3.923.00	327.00	6.08	1.053.00	498.00	103.00	
HEM 240	270.0	18.0	248.0	32.0	21.0	206.0	164.0	200.0	157.0	24.290.0	1.799.0	11.00	8.153.00	657.00	6.39	2.117.00	1.006.00	628.00	

3

3.9 PERFIL H EUROPEO DE ALA ANCHA - HE

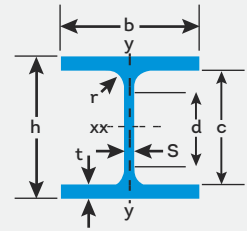

PERFIL H EUROPEO DE ALA ANCHA - HE																			
PERFILES HE		DIMENSIONES Y PROPIEDADES PARA EL DISEÑO																	
DESIGNACIÓN	DIMENSIONES							AREA	PESO	PROPIEDADES ELASTICAS						MODULO PLASTICO		CONS TORS	
	ALTURA		ALA		DISTANCIAS					EJE X-X			EJE Y-Y			Zx	Zy		
	h	s	b	t	r	c	d			Ix	Sx	rx	Iy	Sy	ry	cm3	cm3		Jt
mm	mm	mm	mm	mm	mm	mm	cm2	kg/mt	cm4	cm3	mm	cm4	cm3	cm	cm3	cm4			
HEA A 260	244.0	6.5	260.0	9.5	24.0	225.0	177.0	69.0	54.1	7981.0	654.0	10.8	2788.0	214.0	6.4	714.0	328.0	30.3	
HEA 260	250.0	7.5	260.0	12.5	24.0	255.0	177.0	86.8	68.2	10.450.0	836.0	11.0	3.668.0	282.0	6.5	920.0	430.0	52.4	
DIL 260	260.0	7.5	260.0	17.5	24.0	225.0	177.0	113.0	88.6	14.680.0	1.129.0	11.4	5.132.0	395.0	6.7	1.251.0	599.0	110.0	
HEB 260	260.0	10.0	260.0	17.5	24.0	225.0	177.0	118.0	93.0	14.920.0	1.148.0	11.2	5.135.0	395.0	6.6	1.283.0	602.0	124.0	
HEM 260	290.0	18.0	268.0	32.5	24.0	225.0	177.0	220.0	172.0	31.310.0	2.159.0	11.9	10.450.0	780.0	6.9	2.524.0	1.192.0	719.0	
HEA A 280	264.0	7.0	280.0	10.0	24.0	244.0	196.0	78.0	61.2	10.560.0	800.0	11.6	3.664.0	262.0	6.9	873.0	399.0	36.2	
HEA 280	270.0	8.0	280.0	13.0	24.0	244.0	196.0	97.3	76.4	13.670.0	1.013.0	11.9	4.763.0	340.0	7.0	1.112.0	518.0	62.1	
DIL 280	280.0	8.0	280.0	18.0	24.0	244.0	196.0	125.0	98.3	18.970.0	1.355.0	12.3	6.592.0	471.0	7.3	1.497.0	714.0	128.0	
HEB 280	280.0	10.5	280.0	18.0	24.0	244.0	196.0	131.0	103.0	19.270.0	1.376.0	12.1	6.595.0	471.0	7.1	1.534.0	718.0	144.0	
HEM 280	310.0	18.5	288.0	33.0	24.0	244.0	196.0	240.0	189.0	39.550.0	2.551.0	12.8	13.160.0	914.0	7.4	2.966.0	1.397.0	807.0	
HEA A 300	283.0	7.5	300.0	10.5	27.0	262.0	208.0	88.9	69.8	13.800.0	976.0	12.5	4.734.0	316.0	7.3	1.065.0	482.0	49.3	
HEA 300	290.0	8.5	300.0	14.0	27.0	262.0	208.0	113.0	88.3	18.260.0	1.260.0	12.7	6.310.0	421.0	7.5	1.383.0	641.0	85.2	
DIL 300	300.0	8.5	300.0	19.0	27.0	262.0	208.0	143.0	112.0	24.790.0	1.653.0	13.2	8.560.0	571.0	7.8	1.826.0	866.0	165.0	
HEB 300	300.0	11.0	300.0	19.0	27.0	262.0	208.0	149.0	117.0	25.170.0	1.678.0	13.0	8.563.0	571.0	7.6	1.869.0	870.0	185.0	
HEC 300	320.0	16.0	305.0	29.0	27.0	262.0	208.0	225.0	177.0	40.950.0	2.559.0	13.5	13.740.0	901.0	7.8	2.927.0	1.374.0	598.0	
HEM 300	340.0	21.0	310.0	39.0	27.0	262.0	208.0	303.0	238.0	59.200.0	3.482.0	14.0	19.400.0	1.252.0	8.0	4.078.0	1.913.0	1.408.0	
HEA A 320	301.0	8.0	300.0	11.0	27.0	279.0	225.0	94.6	74.2	16.450.0	1.093.0	13.2	4.959.0	331.0	7.2	1.196.0	506.0	55.9	
HEA 320	310.0	9.0	300.0	15.5	27.0	279.0	225.0	124.0	97.6	22.930.0	1.479.0	13.6	6.985.0	466.0	7.5	1.628.0	710.0	108.0	
DIL 320	320.0	9.0	300.0	20.5	27.0	279.0	225.0	154.0	121.0	30.370.0	1.898.0	14.0	9.235.0	616.0	7.7	2.101.0	935.0	203.0	
HEB 320	320.0	11.5	300.0	20.5	27.0	279.0	225.0	161.0	127.0	30.820.0	1.926.0	13.8	9.239.0	616.0	7.6	2.149.0	939.0	225.0	
HEM 320	359.0	21.0	309.0	40.0	27.0	279.0	225.0	312.0	245.0	68.130.0	3.796.0	14.8	19.710.0	1.276.0	8.0	4.435.0	1.951.0	1.501.0	
HEA A 340	320.0	8.5	300.0	11.5	27.0	297.0	243.0	101.0	78.9	19.550.0	1.222.0	13.9	5.185.0	346.0	7.2	1.341.0	529.0	63.1	
HEA 340	330.0	9.5	300.0	16.5	27.0	297.0	243.0	133.0	105.0	27.690.0	1.678.0	14.4	7.436.0	496.0	7.5	1.850.0	756.0	127.0	
DIL 340	340.0	9.5	300.0	21.5	27.0	297.0	243.0	163.0	128.0	36.110.0	2.124.0	14.9	9.686.0	646.0	7.7	2.353.0	981.0	234.0	
HEB 340	340.0	12.0	300.0	21.5	27.0	297.0	243.0	171.0	134.0	36.660.0	2.156.0	14.6	9.690.0	646.0	7.5	2.408.0	986.0	257.0	
HEM 340	377.0	21.0	309.0	40.0	27.0	297.0	243.0	316.0	248.0	76.340.0	4.052.0	15.6	19.710.0	1.276.0	7.9	4.718.0	1.953.0	1.506.0	
HEA A 360	339.0	9.0	300.0	12.0	27.0	315.0	261.0	107.0	83.7	23.040.0	1.359.0	14.7	5.410.0	361.0	7.1	1.495.0	553.0	71.0	
HEA 360	350.0	10.0	300.0	17.5	27.0	315.0	261.0	143.0	112.0	33.090.0	1.891.0	15.2	7.887.0	526.0	7.4	2.088.0	802.0	149.0	
DIL 360	360.0	10.0	300.0	22.5	27.0	315.0	261.0	173.0	136.0	42.540.0	2.363.0	15.7	10.140.0	676.0	7.7	2.621.0	1.027.0	267.0	
HEB 360	360.0	12.5	300.0	22.5	27.0	315.0	261.0	181.0	142.0	43.190.0	2.400.0	15.5	10.140.0	676.0	7.5	2.683.0	1.032.0	292.0	
HEM 360	395.0	21.0	308.0	40.0	27.0	315.0	261.0	319.0	250.0	84.870.0	4.297.0	16.3	19.520.0	1.268.0	7.8	4.989.0	1.942.0	1.507.0	
HEA A 400	378.0	9.5	300.0	13.0	27.0	352.0	298.0	118.0	92.4	31.250.0	1.654.0	16.3	5.861.0	391.0	7.1	1.824.0	600.0	84.7	
HEA 400	390.0	11.0	300.0	19.0	27.0	352.0	298.0	159.0	125.0	45.070.0	2.311.0	16.8	8.564.0	571.0	7.3	2.562.0	873.0	189.0	
DIL 400	400.0	11.0	300.0	24.0	27.0	352.0	298.0	189.0	148.0	56.770.0	2.839.0	17.3	10.810.0	721.0	7.6	3.154.0	1.098.0	325.0	
HEB 400	400.0	13.5	300.0	24.0	27.0	352.0	298.0	198.0	155.0	57.680.0	2.884.0	17.1	10.820.0	721.0	7.4	3.232.0	1.104.0	355.0	
HEM 400	432.0	21.0	307.0	40.0	27.0	352.0	298.0	326.0	256.0	104.100.0	4.820.0	17.9	19.340.0	1.260.0	7.7	5.571.0	1.934.0	1.515.0	
HEA A 450	425.0	10.0	300.0	13.5	27.0	398.0	344.0	127.0	99.7	41.890.0	1.971.0	18.2	6.088.0	406.0	6.9	2.183.0	624.0	95.6	
HEA 450	440.0	11.5	300.0	21.0	27.0	398.0	344.0	178.0	140.0	63.720.0	2.896.0	18.9	9.465.0	631.0	7.3	3.216.0	966.0	244.0	
DIL 450	450.0	11.5	300.0	26.0	27.0	398.0	344.0	208.0	163.0	78.570.0	3.492.0	19.4	11.720.0	781.0	7.5	3.883.0	1.191.0	406.0	
HEB 450	450.0	14.0	300.0	26.0	27.0	398.0	344.0	218.0	171.0	79.890.0	3.551.0	19.1	11.720.0	781.0	7.3	3.982.0	1.198.0	440.0	
HEM 450	478.0	21.0	307.0	40.0	27.0	398.0	344.0	335.0	263.0	131.500.0	5.501.0	19.8	19.340.0	1.260.0	7.6	6.331.0	1.939.0	1.529.0	

3

3.9 PERFIL H EUROPEO DE ALA ANCHA - HE

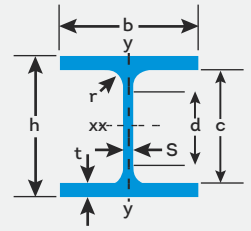

PERFIL H EUROPEO DE ALA ANCHA - HE																			
PERFILES HE		Dimensiones y propiedades para el diseño																	
DESIGNACIÓN	DIMENSIONES							AREA	PESO	PROPIEDADES ELASTICAS						MODULO PLASTICO		CONS TORS	
	ALTURA		ALA		DISTANCIAS					EJE X-X			EJE Y-Y			Zx	Zy		
	h	s	b	t	r	c	d			Ix	Sx	rx	Iy	Sy	ry	cm3	cm3		Jt
mm	mm	mm	mm	mm	mm	mm	mm	cm2	kg/mt	cm4	cm3	cm	cm4	cm3	cm	cm3	cm3	cm4	
HEA A 500	472.0	10.5	300.0	14.0	27.0	444.0	390.0	137.0	107.0	54.640.0	2.315.0	20.0	6.314.0	421.0	6.8	2.576.0	649.0	108.0	
HEA 500	490.0	12.0	300.0	23.0	27.0	444.0	390.0	198.0	155.0	86.970.0	3.550.0	21.0	10.370.0	691.0	7.2	3.949.0	1.059.0	308.0	
DIL 500	500.0	12.0	300.0	28.0	27.0	444.0	390.0	228.0	179.0	105.400.0	4.214.0	21.5	12.620.0	841.0	7.5	4.691.0	1.284.0	499.0	
HEB 500	500.0	14.5	300.0	28.0	27.0	444.0	390.0	239.0	187.0	107.200.0	4.287.0	21.2	12.620.0	842.0	7.3	4.815.0	1.292.0	538.0	
HEM 500	524.0	21.0	306.0	40.0	27.0	444.0	390.0	344.0	270.0	161.900.0	6.180.0	21.7	19.150.0	1.252.0	7.5	7.094.0	1.932.0	1.539.0	
HEA A 550	522.0	11.5	300.0	15.0	27.0	492.0	438.0	153.0	120.0	72.870.0	2.792.0	21.8	6.767.0	451.0	6.7	3.128.0	699.0	134.0	
HEA 550	540.0	12.5	300.0	24.0	27.0	492.0	438.0	212.0	166.0	111.900.0	4.146.0	23.0	10.820.0	721.0	7.2	4.622.0	1.107.0	352.0	
DIL 550	550.0	12.5	300.0	29.0	27.0	492.0	438.0	242.0	190.0	134.200.0	4.880.0	23.6	13.070.0	871.0	7.4	5.439.0	1.332.0	556.0	
HEB 550	550.0	15.0	300.0	29.0	27.0	492.0	438.0	254.0	199.0	136.700.0	4.971.0	23.2	13.080.0	872.0	7.2	5.591.0	1.341.0	600.0	
HEM 550	572.0	21.0	306.0	40.0	27.0	492.0	438.0	354.0	278.0	198.000.0	6.923.0	23.6	19.160.0	1.252.0	7.4	7.933.0	1.397.0	1.554.0	
HEA A 600	571.0	12.0	300.0	15.5	27.0	540.0	486.0	164.0	129.0	91.870.0	3.218.0	23.7	6.993.0	466.0	6.5	3.623.0	724.0	150.0	
HEA 600	590.0	13.0	300.0	25.0	27.0	540.0	486.0	226.0	178.0	141.200.0	4.787.0	25.0	11.270.0	751.0	7.1	5.350.0	1.156.0	398.0	
DIL 600	600.0	13.0	300.0	30.0	27.0	540.0	486.0	256.0	201.0	167.800.0	5.592.0	25.6	13.520.0	901.0	7.3	6.243.0	1.381.0	618.0	
HEB 600	600.0	15.5	300.0	30.0	27.0	540.0	486.0	270.0	212.0	171.000.0	5.701.0	25.2	13.530.0	902.0	7.1	6.425.0	1.391.0	667.0	
HEM 600	620.0	21.0	305.0	40.0	27.0	540.0	486.0	364.0	285.0	237.400.0	7.660.0	25.6	18.980.0	1.244.0	7.2	8.772.0	1.930.0	1.564.0	
HEA A 650	620.0	12.5	300.0	16.0	27.0	588.0	534.0	176.0	138.0	113.900.0	3.676.0	25.5	7.221.0	481.0	6.4	4.160.0	751.0	168.0	
HEA 650	640.0	13.5	300.0	26.0	27.0	588.0	534.0	242.0	190.0	175.200.0	5.474.0	26.9	11.720.0	782.0	7.0	6.136.0	1.205.0	448.0	
HEB 650	650.0	16.0	300.0	31.0	27.0	588.0	534.0	286.0	225.0	210.600.0	6.480.0	27.1	13.980.0	932.0	7.0	7.320.0	1.441.0	739.0	
HEM 650	668.0	21.0	305.0	40.0	27.0	588.0	534.0	374.0	293.0	281.700.0	8.433.0	27.5	18.980.0	1.245.0	7.1	9.657.0	1.936.0	1.579.0	
HEA A 700	670.0	13.0	300.0	17.0	27.0	636.0	582.0	191.0	150.0	142.700.0	4.260.0	27.3	7.673.0	512.0	6.3	4.840.0	800.0	195.0	
HEA 700	690.0	14.5	300.0	27.0	27.0	636.0	582.0	260.0	204.0	215.300.0	6.241.0	28.8	12.180.0	812.0	6.8	7.032.0	1.257.0	514.0	
HEB 700	700.0	17.0	300.0	32.0	27.0	636.0	582.0	306.0	241.0	256.900.0	7.340.0	29.0	14.440.0	963.0	6.9	8.327.0	1.495.0	831.0	
HEM 700	716.0	21.0	304.0	40.0	27.0	636.0	582.0	383.0	301.0	329.300.0	9.198.0	29.3	18.800.0	1.237.0	7.0	10.540.0	1.929.0	1.589.0	
HEA A 800	770.0	14.0	300.0	18.0	30.0	734.0	674.0	218.0	172.0	208.900.0	5.426.0	30.9	8.134.0	542.0	6.1	6.225.0	857.0	257.0	
HEA 800	790.0	15.0	300.0	28.0	30.0	734.0	674.0	286.0	224.0	303.400.0	7.682.0	32.6	12.640.0	843.0	6.7	8.699.0	1.312.0	597.0	
HEB 800	800.0	17.5	300.0	33.0	30.0	734.0	674.0	334.0	262.0	359.100.0	8.977.0	32.8	14.900.0	994.0	6.7	10.230.0	1.553.0	946.0	
HEM 800	814.0	21.0	303.0	40.0	30.0	734.0	674.0	404.0	317.0	442.600.0	10.870.0	33.1	18.630.0	1.230.0	6.8	12.490.0	1.930.0	1.646.0	
HEA A 900	870.0	15.0	300.0	20.0	30.0	830.0	770.0	252.0	198.0	301.100.0	6.923.0	34.6	9.041.0	603.0	6.0	7.999.0	958.0	335.0	
HEA 900	890.0	18.0	300.0	30.0	30.0	830.0	770.0	321.0	252.0	422.100.0	9.485.0	36.3	13.550.0	903.0	6.5	10.810.0	1.414.0	737.0	
HEB 900	900.0	18.5	300.0	35.0	30.0	830.0	770.0	371.0	291.0	494.100.0	10.980.0	36.5	15.820.0	1.054.0	6.5	12.580.0	1.658.0	1.137.0	
HEM 900	910.0	21.0	302.0	40.0	30.0	830.0	770.0	424.0	333.0	570.400.0	12.540.0	36.7	18.450.0	1.222.0	6.6	14.440.0	1.929.0	1.671.0	
HEA A 1000	970.0	16.0	300.0	21.0	30.0	928.0	868.0	282.0	222.0	406.500.0	8.380.0	38.0	9.501.0	633.0	5.8	9.777.0	1.016.0	403.0	
HEA 1000	990.0	16.5	300.0	31.0	30.0	928.0	868.0	347.0	272.0	553.800.0	11.190.0	40.0	14.000.0	934.0	6.4	12.820.0	1.470.0	822.0	
HEB 1000	1.000.0	19.0	300.0	36.0	30.0	928.0	838.0	400.0	314.0	644.700.0	12.890.0	40.1	16.280.0	1.085.0	6.4	14.860.0	1.716.0	1.254.0	
HEM 1000	1.008.0	21.0	302.0	40.0	30.0	928.0	868.0	444.0	349.0	722.300.0	14.330.0	40.3	18.460.0	1.222.0	6.5	16.570.0	1.940.0	1.701.0	
HEA 1100	1.090.0	18.0	300.0	31.0	20.0	1.028.0	988.0	374.0	294.0	693.500.0	12.720.0	43.0	14.010.0	934.0	6.1	14.780.0	1.483.0	839.0	
HEB 1100	1.100.0	20.0	300.0	36.0	20.0	1.028.0	988.0	425.0	334.0	801.500.0	14.570.0	43.4	16.280.0	1.085.0	6.2	16.950.0	1.728.0	1.253.0	
HEM 1100	1.108.0	22.0	302.0	40.0	20.0	1.028.0	988.0	471.0	370.0	897.300.0	16.200.0	43.6	18.460.0	1.223.0	6.3	18.890.0	1.954.0	1.703.0	
HE 1100	1.118.0	26.0	305.0	45.0	20.0	1.028.0	988.0	545.0	428.0	1.034.900.0	18.510.0	43.6	21.440.0	1.406.0	6.3	21.770.0	2.273.0	2.527.0	

3

3.10 PERFIL H DE ALA ANCHA (COLUMNAS) HD

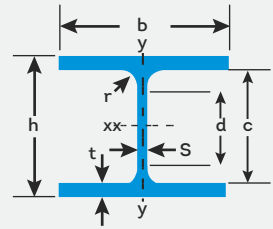

PERFIL H DE ALA ANCHA (COLUMNAS) - HD																			
PERFILES HD		Dimensiones y propiedades para el diseño																	
DESIGNACIÓN	DIMENSIONES								PROPIEDADES ELÁSTICAS						MODULO PLÁSTICO		CONS TORS		
	ALTURA		ALA		DISTANCIAS				AREA	PESO	EJE X-X			EJE Y-Y			Zx	Zy	Jt
	h	s	b	t	r	c	d	ix			Sx	rx	Iy	Sy	ry	cm3			
mm	mm	mm	mm	mm	mm	mm	mm	cm ²	kg/mt	cm ⁴	cm ³	cm	cm ⁴	cm ³	cm	cm ³	cm ³	cm ⁴	
HD 210 X 46	203.0	7.0	203.0	11.0	10.0	181.0	161.0	58.2	46.0	4.533.0	447.0	8.83	1.534.0	151.00	5.14	494.0	229.0	219	
HD 210 X 52	206.0	8.0	204.0	12.5	10.0	181.0	161.0	66.3	52.0	5.243.0	509.0	8.89	1.770.0	174.00	5.17	567.0	264.0	32.0	
HD 210 X 59	209.0	9.0	205.0	14.0	10.0	181.0	161.0	74.5	59.0	5.978.0	572.0	8.95	2.012.0	196.00	5.19	641.0	298.0	44.9	
HD 210 X 71	216.0	10.0	206.0	17.5	10.0	181.0	161.0	91.1	71.0	7.682.0	711.0	9.18	2.552.0	248.00	5.29	805.0	376.0	82.7	
HD 210 X 87	222.0	13.5	209.0	20.5	10.0	181.0	161.0	111.0	87.0	9.462.0	852.0	9.23	3.124.0	299.00	5.31	981.0	457.0	142.0	
HD 210 X 100	229.0	14.5	210.0	24.0	10.0	181.0	161.0	128.0	100.0	11.420.0	998.0	9.45	3.710.0	353.00	5.39	1.160.0	540.0	218.0	
HD 210 X 118	237.0	17.0	213.0	28.0	10.0	181.0	161.0	151.0	118.0	14.010.0	1.182.0	9.64	4.518.0	424.00	5.47	1.393.0	649.0	349.0	
HD 210 X 138	245.0	20.0	216.0	32.0	10.0	181.0	161.0	175.0	138.0	16.850.0	1.376.0	9.80	5.388.0	499.00	5.54	1.644.0	766.0	531.0	
HD 210 X 161	255.0	23.0	219.0	37.0	10.0	181.0	161.0	205.0	161.0	20.640.0	1.619.0	10.00	6.497.0	593.00	5.64	1.962.0	912.0	823.0	
HD 210 X 198	271.0	27.5	224.0	45.0	10.0	181.0	161.0	252.0	198.0	27.510.0	2.030.0	10.40	8.463.0	756.00	5.79	2.511.0	1.165.0	1.484.0	
HD 210 X 249	291.0	34.5	231.0	55.0	10.0	181.0	161.0	317.0	249.0	37.790.0	2.597.0	10.90	11.360.00	984.00	5.98	3.289.00	1.523.00	2.789.00	
HD 260 X 73	253.0	9.0	254.0	14.0	13.0	225.0	199.0	92.8	73.0	11.200.0	885.0	11.00	3.826.00	301.00	6.42	980.0	457.0	57.0	
HD 260 X 80	256.0	9.5	255.0	15.5	13.0	225.0	199.0	102.0	80.0	12.520.0	978.0	11.10	4.286.00	336.00	6.49	1.087.0	510.0	75.3	
HD 260 X 89	260.0	10.0	256.0	17.5	13.0	225.0	199.0	114.0	89.0	14.320.0	1.101.0	11.20	4.896.00	383.00	6.57	1.229.0	580.0	105.0	
HD 260 X 101	264.0	12.0	257.0	19.5	13.0	225.0	199.0	129.0	101.0	16.320.0	1.237.0	11.30	5.521.00	430.00	6.55	1.393.0	653.0	149.0	
HD 260 X 115	269.0	14.0	259.0	22.0	13.0	225.0	199.0	147.0	115.0	18.930.0	1.407.00	11.40	6.377.00	492.00	6.59	1.600.0	750.0	217.0	
HD 260 X 131	275.0	15.5	261.0	25.0	13.0	225.0	199.0	167.0	131.0	22.100.0	1.608.0	11.50	7.417.0	568.00	6.67	1.843.0	867.0	314.0	
HD 260 X 149	282.0	17.0	263.0	28.5	13.0	225.0	199.0	190.0	149.0	25.970.0	1.842.0	11.70	8.652.0	658.00	6.76	2.131.0	1.004.0	458.0	
HD 260 X 167	288.0	19.5	265.0	31.5	13.0	225.0	199.0	212.0	167.0	29.620.0	2.057.00	11.80	9.786.00	739.00	6.79	2.404.0	1.129.0	629.0	
HD 260 X 191	297.0	22.0	267.0	36.0	13.0	225.0	199.0	243.0	191.0	35.210.0	2.371.0	12.00	11.440.0	857.00	6.86	2.803.0	1.312.0	933.0	
HD 260 X 219	307.0	25.0	270.0	41.0	13.0	225.0	199.0	279.0	219.0	42.020.0	2.738.0	12.30	13.480.0	999.00	6.95	3.277.0	1.532.0	1.382.0	
HD 260 X 252	319.0	28.0	273.0	47.0	13.0	225.0	199.0	321.0	252.0	50.770.0	3.183.0	12.60	15.980.00	1.171.00	7.06	3.860.0	1.798.0	2.066.00	
HD 260 X 288	331.0	32.0	277.0	53.0	13.0	225.0	199.0	367.0	288.0	60.630.0	3.663.00	12.90	18.840.0	1.360.00	7.16	4.502.00	2.094.00	3.000.00	
HD 260 X 329	345.0	36.0	281.0	60.0	13.0	225.0	199.0	420.0	329.0	73.080.0	4.236.0	13.20	22.280.0	1.586.00	7.29	5.277.0	2.445.0	4.365.0	
HD 310 X 97	308.00	10.00	305.00	15.50	15.00	277.00	247.00	124.00	97.00	22.370.00	1.452.00	13.40	7.333.00	481.00	7.68	1.601.00	729.00	93.40	
HD 310 X 107	311.00	11.00	306.00	17.00	15.00	277.00	247.00	136.00	107.00	24.810.00	1.595.00	13.50	8.123.00	531.00	7.72	1.766.00	806.00	123.00	
HD 310 X 117	314.00	12.00	307.00	18.50	15.00	277.00	247.00	149.00	117.00	27.310.00	1.739.00	13.50	8.927.00	582.00	7.75	1.935.00	884.00	158.00	
HD 310 X 130	318.00	13.50	308.00	20.50	15.00	277.00	247.00	166.00	130.00	30.730.00	1.933.00	13.60	9.991.00	649.00	7.77	2.163.00	987.00	215.00	
HD 310 X 143	323.00	14.00	308.00	23.00	15.00	277.00	247.00	182.00	143.00	34.770.00	2.153.00	13.80	11.210.00	728.00	7.84	2.420.00	1.107.00	291.00	
HD 310 X 158	327.00	16.00	310.00	25.00	15.00	277.00	247.00	201.00	158.00	38.610.00	2.361.00	13.90	12.430.00	802.00	7.86	2.674.00	1.221.00	382.00	
HD 310 X 179	333.00	18.50	313.00	28.00	15.00	277.00	247.00	228.00	179.00	44.510.00	2.673.00	14.00	14.330.00	916.00	7.92	3.054.00	1.398.00	546.00	
HD 310 X 202	340.00	20.50	315.00	31.50	15.00	277.00	247.00	257.00	202.00	51.370.00	3.021.00	14.10	16.430.00	1.043.00	7.99	3.480.00	1.595.00	772.00	
HD 310 X 227	348.00	22.50	317.00	35.50	15.00	277.00	247.00	289.00	227.00	59.520.00	3.421.00	14.30	18.880.00	1.191.00	8.08	3.974.00	1.822.00	1.090.00	
HD 310 X 253	356.00	24.50	319.00	39.50	15.00	277.00	247.00	322.00	253.00	68.130.00	3.828.00	14.60	21.410.00	1.342.00	8.16	4.484.00	2.054.00	1.488.00	
HD 310 X 283	365.00	27.00	322.00	44.00	15.00	277.00	247.00	360.00	283.00	78.590.00	4.306.00	14.80	24.530.00	1.524.00	8.25	5.092.00	2.335.00	2.054.00	
HD 310 X 313	374.00	29.50	325.00	48.50	15.00	277.00	247.00	399.00	313.00	89.700.00	4.797.00	15.00	27.810.00	1.712.00	8.35	5.723.00	2.625.00	2.750.00	
HD 310 X 343	382.00	32.50	328.00	52.50	15.00	277.00	247.00	436.00	343.00	100.400.00	5.255.00	15.20	30.960.00	1.888.00	8.42	6.324.00	2.901.00	3.530.00	
HD 310 X 375	391.00	36.00	330.00	57.00	15.00	277.00	247.00	478.00	375.00	112.700.00	5.763.00	15.40	34.260.00	2.076.00	8.47	6.999.00	3.198.00	4.566.00	
HD 310 X 415	403.00	38.00	334.00	63.00	15.00	277.00	247.00	528.00	415.00	130.100.00	6.456.00	15.70	39.260.00	2.351.00	8.62	7.909.00	3.618.00	6.072.00	
HD 310 X 454	415.00	40.50	336.00	69.00	15.00	277.00	247.00	578.00	454.00	148.100.00	7.139.00	16.00	43.790.00	2.606.00	8.71	8.825.00	4.013.00	7.886.00	
HD 310 X 500	427.00	45.00	340.00	75.00	15.00	277.00	247.00	637.00	500.00	168.700.00	7.901.00	16.30	49.350.00	2.903.00	8.81	9.865.00	4.480.00	10.280.00	

3

3.10 PERFIL H DE ALA ANCHA (COLUMNAS) HD

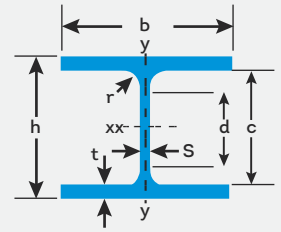

PERFIL H DE ALA ANCHA (COLUMNAS) - HD																			
PERFILES HD	DIMENSIONES Y PROPIEDADES PARA EL DISEÑO																		
	DIMENSIONES								AREA	PESO	PROPIEDADES ELASTICAS						MODULO PLASTICO		CONS TORS
	ALTURA		ALA		DISTANCIAS						EJE X-X			EJE Y-Y			Zx	Zy	
	h	s	b	t	r	c	d	Ix			Sx	rx	Iy	Sy	ry	Zx	Zy		
mm	mm	mm	mm	mm	mm	mm	cm ²	kg/mt	cm ⁴	cm ³	cm	cm ⁴	cm ³	cm	cm ³	cm ³	cm ⁴		
HD 360 X 134	356.0	11.5	368.0	18.0	15.0	320.0	290.0	171.0	134.0	41.490.0	2.231.0	15.60	14.960.0	813.0	9.35	2.564.0	1.231.0	170.0	
HD 360 X 148	360.0	12.0	370.0	20.0	15.0	320.0	290.0	188.0	148.0	46.570.0	2.587.0	15.70	16.890.0	913.0	9.47	2.853.0	1.382.0	227.0	
HD 360 X 162	364.0	13.0	371.0	22.0	15.0	320.0	290.0	207.0	162.0	51.820.0	2.847.0	15.80	18.730.0	1.010.0	9.52	3.154.0	1.529.0	300.0	
HD 360 X 179	368.0	15.0	372.0	24.0	15.0	320.0	290.0	228.0	179.0	57.480.0	3.124.0	15.90	20.600.00	1.108.0	9.50	3.485.0	1.681.0	397.0	
HD 360 X 196	372.0	16.5	374.0	26.0	15.0	320.0	290.0	249.0	196.0	63.300.0	3.403.0	15.90	22.680.0	1.213.0	9.54	3.817.0	1.842.0	509.0	
HD 400 X 187	368.0	15.0	391.0	24.0	15.0	320.0	290.0	238.0	187.0	60.180.0	3.271.0	15.90	23.920.0	1.224.0	10.00	3.642.0	1.855.0	415.0	
HD 400 X 216	375.0	17.5	394.0	27.5	15.0	320.0	290.0	375.0	216.0	70.810.0	3.776.0	16.10	28.050.0	1.424.0	10.10	4.243.0	2.161.0	629.0	
HD 400 X 237	381.0	18.5	395.0	30.5	15.0	320.0	290.0	302.0	237.0	79.710.0	4.184.0	16.20	31.350.0	1.587.0	10.20	4.727.0	2.409.0	840.0	
HD 400 X 262	387.0	20.5	397.0	33.5	15.0	320.0	290.0	334.0	262.0	89.420.0	4.621.0	16.40	34.960.0	1.761.0	10.20	5.256.00	2.676.0	1.117.0	
HD 400 X 288	393.0	23.0	399.0	36.5	15.0	320.0	290.0	367.0	288.0	99.620.0	5.070.0	16.50	38.680.0	1.939.0	10.30	5.811.0	2.951.0	1.464.0	
HD 400 X 314	400.0	24.5	400.0	40.0	15.0	320.0	290.0	400.0	314.0	111.300.0	5.564.0	16.70	42.710.0	2.136.0	10.30	6.417.0	3.251.00	1.903.0	
HD 400 X 347	407.0	27.5	404.0	43.5	15.0	320.0	290.0	441.0	347.0	124.600.0	6.125.0	16.80	47.870.0	2.370.0	10.40	7.122.0	3.614.0	2.492.0	
HD 400 X 383	416.0	30.0	406.0	48.0	15.0	320.0	290.0	448.0	383.0	141.400.0	6.797.0	17.00	53.620.0	2.641.0	10.50	7.970.0	4.032.0	3.335.00	
HD 400 X 422	425.0	33.0	409.0	52.5	15.0	320.0	290.0	537.0	422.0	159.400.0	7.503.0	17.20	59.970.0	2.932.0	10.60	8.874.0	4.482.0	4.388.0	
HD 400 X 463	435.0	35.5	412.0	57.5	15.0	320.0	290.0	589.0	463.0	180.300.00	8.288.0	17.50	67.150.0	3.260.0	10.70	9.882.0	4.985.0	5.740.0	
HD 400 X 509	445.0	39.5	416.0	62.5	15.0	320.0	290.0	648.0	509.0	203.200.0	9.130.0	17.70	75.170.0	3.614.0	10.80	10.990.0	5.537.0	7.483.0	
HD 400 X 551	455.0	42.5	418.0	67.5	15.0	320.0	290.0	702.0	551.0	226.100.0	9.936.0	17.90	82.380.0	3.942.0	10.80	12.050.0	6.046.0	9.423.0	
HD 400 X 593	465.0	44.5	421.0	72.5	15.0	320.0	290.0	755.0	593.0	250.400.0	10.770.0	18.20	90.410.0	4.295.0	10.90	13.150.0	6.588.0	11.590.0	
HD 400 X 634	475.0	47.0	423.0	77.5	15.0	320.0	290.0	808.0	634.0	275.600.0	11.600.0	18.50	98.050.0	4.636.0	11.00	14.260.0	7.115.0	14.100.0	
HD 400 X 678	484.0	50.5	427.0	82.0	15.0	320.0	290.0	864.0	678.0	301.100.0	12.440.0	18.70	106.800.0	5.000.0	11.10	15.400.0	7.685.0	16.910.0	
HD 400 X 744	499.0	54.5	431.0	89.5	15.0	320.0	290.0	948.0	744.0	343.900.0	13.780.0	19.00	119.900.0	5.563.0	11.20	17.220.0	8.556.0	21.970.0	
HD 400 X 818	514.0	60.5	437.0	97.0	15.0	320.0	290.0	1.043.0	818.0	392.200.0	15.260.0	19.40	135.500.0	6.203.0	11.40	19.260.0	9.561.0	28.510.00	
HD 400 X 900	531.0	65.5	442.0	106.0	15.0	320.0	290.0	1.149.0	900.0	450.200.0	16.960.0	19.80	153.300.0	6.938.0	11.60	21.620.0	10.710.0	37.350.0	
HD 400 X 990	550.0	71.9	448.0	115.0	15.0	320.0	290.0	1.262.0	990.0	518.900.0	18.870.0	20.30	173.400.0	7.739.0	11.70	24.210.0	11.960.0	48.210.0	
HD 400 X 1086	569.0	78.0	454.0	125.0	15.0	320.0	290.0	1.386.0	1.086.0	595.700.0	20.940.0	20.70	192.200.0	8.645.0	11.90	27.210.0	13.380.0	62.290.00	

3

3.11 PERFIL H DE ALA EXTRA ANCHA - HL Y HX

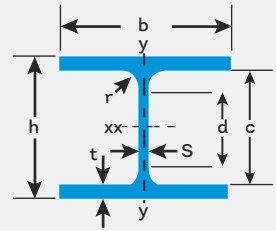

PERFIL EUROPEO DE ALA EXTRA ANCHA - HL																			
PERFILES HL	DIMENSIONES Y PROPIEDADES PARA EL DISEÑO																		
	DIMENSIONES								AREA	PESO	PROPIEDADES ELASTICAS						MODULO PLASTICO		CONS TORS
	ALTURA		ALA		DISTANCIAS						EJE X-X			EJE Y-Y			Zx	Zy	
DESIGNACIÓN	h	s	b	t	r	c	d	cm ²	kg/mt	Ix	Sx	rx	Iy	Sy	ry	cm ³	cm ³	Jt	
HLA A 1000	970.0	16.5	400.0	21.0	30.0	928.0	868.0	329.0	258.00	504.400.0	10.400.0	39.20	22.450.0	1.123.0	8.26	11.880.00	1.755.00	483.00	
HLA 1000	990.0	16.5	400.0	31.0	30.0	928.0	868.0	409.0	321.00	696.400.0	14.070.0	41.30	33.120.0	1.656.0	9.00	15.800.00	2.555.00	1.021.00	
HLB 1000	1.000.0	19.0	400.0	36.0	30.0	928.0	868.0	472.0	371.00	812.100.0	16.240.00	41.50	38.480.0	1.924.0	9.03	18.330.00	2.976.00	1.565.00	
HLM 1000	1.008.0	21.0	402.0	40.0	30.0	928.0	868.0	524.0	412.00	909.800.0	18.050.0	41.70	43.410.0	2.160.0	9.10	20.440.00	3.348.00	2.128.00	
HL 1000 X 477	1.018.0	25.5	404.0	45.0	30.0	928.0	868.0	608.0	477.30	1.047.200.0	20.573.00	41.50	49.614.0	2.456.0	9.00	23.532.00	3.838.00	-	
HL 1000 X 554	1.032.00	29.5	408.0	52.0	30.0	928.0	868.0	706.0	554.10	1.232.400.0	23.883.0	41.80	59.098.00	2.897.0	9.20	27.496.00	4.546.00	-	
HL 1000 X 642	1.048.0	34.0	412.0	60.0	30.0	928.0	868.0	818.0	641.90	1.450.600.0	27.683.0	42.10	70.284.0	3.411.0	9.30	32.097.00	5.378.00	-	
HL 1000 X 748	1.068.0	39.0	417.0	70.0	30.0	928.0	868.0	953.0	748.50	1.731.900.0	32.433.0	42.60	85.111.0	4.082.0	9.40	37.881.00	6.459.00	-	
HLA 1100	1.090.0	18.0	400.0	31.0	20.0	1.028.0	988.0	436.0	342.60	867.390.0	15.915.0	44.60	33.123.0	1.656.0	8.70	18.062.00	2.568.00	-	
HLB 1100	1.100.0	20.0	400.0	36.0	20.0	1.028.0	988.0	497.0	390.20	1.005.400.0	18.280.00	45.00	38.476.0	1.924.0	8.80	20.780.00	2.988.00	-	
HLM 1100	1.108.0	22.0	402.0	40.0	20.0	1.028.0	988.0	551.0	432.70	1.125.600.0	20.317.0	45.20	43.410.0	2.159.0	8.90	23.161.00	3.362.00	-	

PERFIL EUROPEO DE ALA EXTRA ANCHA - HX																			
PERFILES HX	DIMENSIONES Y PROPIEDADES PARA EL DISEÑO																		
	DIMENSIONES								AREA	PESO	PROPIEDADES ELASTICAS						MODULO PLASTICO		CONS TORS
	ALTURA		ALA		DISTANCIAS						EJE X-X			EJE Y-Y			Zx	Zy	
DESIGNACIÓN	h	s	b	t	r	c	d	cm ²	kg/mt	Ix	Sx	rx	Iy	Sy	ry	cm ³	cm ³	Jt	
HXA A 1000	970.0	18.0	450.0	21.0	30.0	928.0	868.0	364.0	286.0	561.600.0	11.580.0	39.30	31.960.0	1.420.0	9.37	13.200.0	2.214.0	574.0	
HXA 1000	992.0	18.0	450.0	32.0	30.0	928.0	868.0	463.0	363.0	799.800.0	16.130.0	41.60	48.670.0	2.163.0	10.30	18.050.0	3.327.0	1.268.0	
HXB 1000	1.000.0	19.0	451.0	36.0	30.0	928.0	868.0	509.0	399.0	897.400.0	17.950.0	42.00	55.120.0	2.444.0	10.40	20.100.0	3.757.0	1.724.0	
HXM 1000	1.008.0	21.1	453.0	40.0	30.0	928.0	868.0	565.0	444.0	1.005.400.0	19.950.0	42.20	62.070.0	2.740.0	10.50	22.410.0	4.220.0	2.346.0	
HXR 1000	1.016.0	23.0	455.0	44.0	30.0	928.0	868.0	622.0	488.0	1.115.700.0	21.960.0	42.40	69.200.0	3.042.0	10.60	24.760.0	4.691.0	3.103.0	

3

3.12 PERFIL H DE ALA ANCHA (PILOTES) - HP

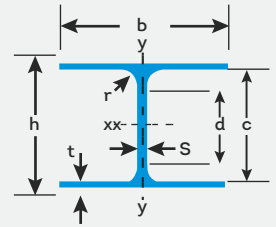

PERFIL H DE ALA ANCHA (PILOTES) - HP																			
PERFILES HP	DIMENSIONES Y PROPIEDADES PARA EL DISEÑO																		
	DIMENSIONES								AREA	PESO	PROPIEDADES ELASTICAS						MODULO PLASTICO		CONS TORS
	ALTURA		ALA		DISTANCIAS						EJE X-X			EJE Y-Y			Zx	Zy	
	h	s	b	t	r	c	d	Ix			Sx	rx	Iy	Sx	ry	cm ³	cm ³	Jt	
mm	mm	mm	mm	mm	mm	mm	cm ²	kg/mt	cm ⁴	cm ³	cm	cm ⁴	cm ³	cm	cm ³	cm ³	cm ⁴		
HP 200 X 43	200.0	9.00	205.0	9.00	10.0	182.00	162.0	54.10	43.16	3.888.0	389.0	8.47	1.294.0	126.0	4.89	435.0	193.0	177	
HP 200 X 53	204.0	11.30	207.0	11.30	10.0	181.40	161.4	68.10	53.57	4.977.0	488.0	8.55	1.673.0	162.0	4.96	551.0	249.0	34.2	
HP 250 X 53	243.0	9.00	254.0	9.00	13.0	225.00	199.0	67.40	53.57	7.290.00	600.0	10.40	2.460.0	194.0	6.04	665.0	296.0	23.3	
HP 250 X 62	246.0	10.50	256.0	10.70	13.0	224.60	198.6	79.80	62.50	8.753.0	712.0	10.50	2.995.0	234.0	6.13	793.0	358.0	37.0	
HP 250 X 85	254.0	14.40	260.0	14.40	13.0	225.20	199.2	109.00	84.83	12.300.0	969.0	10.60	4.225.0	325.0	6.23	1.096.0	500.0	89.3	
HP 310 X 64	295.0	9.00	304.0	9.00	15.0	277.00	247.0	81.60	63.99	13.140.0	891.0	12.70	4.217.0	277.0	7.19	981.0	423.0	28.9	
HP 310 X 79	299.0	11.00	306.0	11.00	15.0	277.00	247.0	99.70	78.87	16.270.0	1.088.0	12.80	5.258.0	344.0	7.26	1.207.0	525.0	50.3	
HP 310 X 93	303.0	13.10	308.0	13.10	15.0	276.80	246.8	119.00	93.75	19.630.0	1.296.0	12.90	6.367.0	415.0	7.33	1.447.0	635.0	82.5	
HP 310 X 110	308.0	15.40	310.0	15.50	15.0	277.00	247.0	141.00	110.12	23.650.0	1.536.0	13.00	7.707.0	497.0	7.40	1.727.0	763.0	133.0	
HP 310 X 125	312.0	17.40	312.0	17.40	15.0	277.20	247.2	159.00	125.01	27.030.0	1.733.0	13.00	8.823.0	566.0	7.46	1.960.0	870.0	188.0	
HP 370 X 84	340.0	10.00	367.0	10.00	15.0	320.00	290.0	107.00	83.34	23.190.0	1.364.0	14.70	8.243.0	449.0	8.76	1.497.0	683.0	44.2	
HP 370 X 108	346.0	12.80	370.0	12.80	15.0	320.40	290.4	138.00	108.64	30.290.0	1.751.0	14.80	10.810.0	585.0	8.86	1.937.0	891.0	89.0	
HP 370 X 132	351.0	15.60	373.0	15.60	15.0	319.80	289.8	168.00	132.45	37.480.0	2.135.0	14.90	13.510.0	724.0	8.96	2.381.0	1.107.0	158.0	
HP 370 X 152	356.0	17.90	376.0	17.90	15.0	320.20	290.2	194.00	151.79	43.880.0	2.465.0	15.00	15.880.0	845.0	9.05	2.765.0	1.293.0	237.0	
HP 370 X 174	361.0	20.40	378.0	20.40	15.0	320.20	290.2	221.00	174.12	50.840.0	2.816.0	15.20	18.390.0	973.0	9.11	3.180.0	1.493.0	349.0	
HP 400 X 104	344.0	12.00	387.0	12.00	15.0	320.00	290.0	133.00	104.17	29.360.0	1.707.0	14.80	11.600.00	599.0	9.33	1.879.0	912.0	76.0	
HP 400 X 122	348.0	14.00	390.0	14.00	15.0	320.00	290.0	156.00	122.03	34.770.0	1.998.0	14.90	13.850.0	710.0	9.42	2.212.0	1.082.0	119.0	
HP 400 X 140	352.0	16.00	392.0	16.00	15.0	320.00	290.0	179.00	139.89	40.270.0	2.288.0	15.00	16.080.0	820.0	9.49	2.547.0	1.252.0	175.0	
HP 400 X 158	356.0	18.00	394.0	18.00	15.0	320.00	290.0	201.00	157.75	45.940.0	2.581.0	15.10	18.370.0	932.0	9.55	2.888.00	1.425.0	248.0	
HP 400 X 176	360.0	20.00	396.0	20.00	15.0	320.00	290.0	224.00	175.60	51.770.0	2.876.0	15.20	20.720.0	1.047.0	9.61	3.235.0	1.603.0	339.0	
HP 400 X 194	364.0	22.00	398.0	22.00	15.0	320.00	290.0	247.00	193.46	57.760.0	3.174.0	15.30	23.150.0	1.163.0	9.67	3.588.0	1.784.0	450.0	
HP 400 X 213	368.0	24.00	400.0	24.00	15.0	320.00	290.0	271.00	212.81	63.920.0	3.474.0	15.40	25.640.0	1.282.0	9.73	3.947.0	1.969.0	584.0	
HP 400 X 231	372.0	26.00	402.0	26.00	15.0	320.00	290.0	294.00	230.67	70.260.00	3.777.0	15.50	28.200.0	1.403.0	9.79	4.312.0	2.158.0	743.0	

3

3.13 PERFILES TIPO AMERICANO - CALIDADES DE ACEROS Y TOLERANCIAS

CALIDADES DE ACERO UTILIZADO PARA FABRICACION DE PERFILES TIPO AMERICANO (WF, C, I y L)																			
CALIDADES MAS COMUNES	COMPOSICION QUIMICA													PROPIEDADES MECANICAS					
	L	C	Mn	P	S	Si	Cu	Ni	Cr	Mo	Nb	V	CE	LIMITE ELÁSTICO		RESISTENCIA A LA TRACCIÓN		% ALARGA	
ASTM		(x 100)	(x 100)	(x 100)	(x 100)	(x 100)	(x 100)	(x 100)	(x 100)	(x 100)	(x 100)	(x 100)	(x 100)						
A - 36	MIN		80			15									23Kg		41Kg/mm ²	400MPa	20
	MAX	26	120	5	4	40									25Kg/mm ³	250MPa	56Kg/mm ²	550MPa	21
A-572-GR 50	MIN														-	-			18
	MAX	23	135	5	4	40									35Kg/mm ²	345MPa	46Kg/mm ²	450MPa	21
A-572-GR 60	MIN														-	-			16
	MAX	26	135	5	4	40									42Kg/mm ²	415MPa	53Kg/mm ²	520MPa	18
A-588-GR B	MIN		75			15	20		40										18
	MAX	20	135	5	4	50	40		70						35Kg/mm ²	345MPa	49Kg/mm ²	485MPa	21
A-913-GR 50	MIN																		18
	MAX	12	160	3	4	40	45	25	25	7	5	6	38		35Kg/mm ²	345MPa	46Kg/mm ²	450MPa	21
A-992-GR A992	MIN		50												35Kg/mm ²	345MPa			18
	MAX	23	150	4	3,5	40	60	45	35	15	5	11	45		46Kg/mm ²	450MPa	46Kg/mm ²	450MPa	21

FORMATO DE PERFILES MÁS COMERCIALES EN COLOMBIA

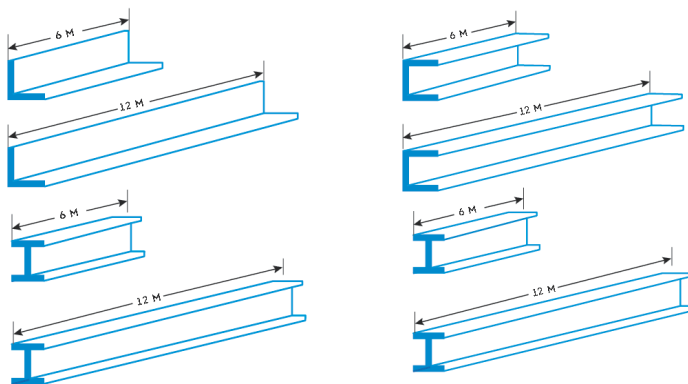

3

3.14 ÁNGULO TIPO AMERICANO DE LADOS IGUALES

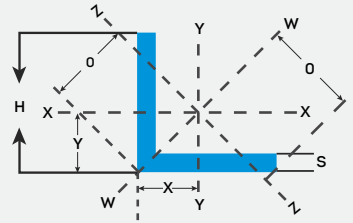

ÁNGULO TIPO AMERICANO DE LADOS IGUALES																	
Dimensiones y propiedades para el diseño																	
PERFILES EN L	DIMENSIONES			DISTANCIAS DE LOS EJES			AREA	PESO	PROPIEDADES ELASTICAS								
	ALTURA=ALA		RADIOS	EJES					EJE X-X = Y-Y			EJE W-W			EJE Z-Z		
DESIGNACIÓN	h	s	r1	x=y	w	z	cm2	kg/mt	Ix	Sx	rx	In	rn	Iz	Sz	rz	cm
	mm	mm	mm	cm	cm	cm			cm4	cm3	cm	cm4	cm	cm4	cm3	cm	
L 1/8" X 3/4"	19.05	3.17	3.20	0.58	1.34	0.82	1.11	0.88	0.37	0.28	0.58	0.58	0.73	0.16	0.19	0.38	
L 1/8" X 1"	25.40	3.17	3.20	0.76	1.79	1.07	1.52	1.19	0.92	0.51	0.79	1.24	0.93	0.41	0.38	0.48	
L 1/8" X 1 1/4"	31.75	3.17	4.70	0.89	2.24	1.25	1.93	1.50	1.83	0.80	0.97	2.91	1.19	0.83	0.66	0.60	
L 1/8" X 1 1/2"	38.10	3.17	4.70	1.07	2.69	1.51	2.34	1.83	3.25	1.18	1.17	5.41	1.47	1.24	0.82	0.73	
L 1/8" X 2"	50.80	3.17	6.30	1.40	3.58	1.97	3.10	2.46	7.91	2.13	1.60	12.49	1.97	3.32	1.68	0.99	
L 3/16" X 1"	25.40	4.76	3.20	0.81	1.79	1.14	2.21	1.73	1.25	0.72	0.76	2.08	0.93	0.41	0.36	0.48	
L 3/16" X 1 1/4"	31.75	4.76	4.70	0.97	2.24	1.37	2.79	2.20	2.54	1.16	0.97	3.74	1.19	0.83	0.61	0.60	
L 3/16" X 1 1/2"	38.10	4.76	4.70	1.12	2.69	1.58	3.43	2.68	4.58	1.64	1.17	7.07	1.44	1.66	1.05	0.73	
L 3/16" X 2"	50.80	4.76	6.30	1.45	3.58	2.00	4.61	3.63	11.45	3.11	1.57	17.48	1.95	4.57	2.28	0.99	
L 3/16" X 2 1/2"	63.50	4.76	6.30	1.75	4.49	2.47	5.81	4.61	22.89	4.92	1.98	36.52	2.46	9.15	3.70	1.24	
L 3/16" X 3"	76.20	4.76	7.90	2.08	5.38	2.94	7.03	5.52	40.01	7.22	2.39	64.38	3.03	16.12	5.48	1.51	
L 1/4" X 1"	25.4	6.35	3.20	0.86	1.79	1.21	2.80	2.22	1.54	0.92	0.74	2.49	0.91	0.83	0.69	0.48	
L 1/4" X 1 1/4"	31.75	6.35	4.70	1.02	2.24	1.44	3.72	2.86	3.21	1.49	0.94	4.99	1.16	1.24	0.86	0.60	
L 1/4" X 1 1/2"	38.10	6.35	4.70	1.19	2.69	1.68	4.40	3.48	5.83	2.20	1.14	8.74	1.42	2.49	1.48	0.73	
L 1/4" X 2"	50.80	6.35	6.30	1.50	3.58	2.10	6.06	4.75	14.57	4.10	1.55	22.47	1.93	5.82	2.77	0.99	
L 1/4" X 2 1/2"	63.50	6.35	6.30	1.83	4.49	2.54	7.68	6.10	29.14	6.39	1.96	45.36	2.43	11.65	4.58	1.24	
L 1/4" X 3"	76.20	6.35	7.90	2.13	5.38	2.97	9.29	7.29	51.60	9.50	2.36	78.66	2.94	20.39	6.86	1.49	
L 1/4" X 4"	101.60	6.35	9.50	2.77	7.18	3.91	12.52	9.82	124.90	17.20	3.18	191.39	3.96	48.10	12.30	2.00	
L 5/16" X 2"	50.80	7.94	6.30	1.55	3.58	2.18	7.42	5.83	17.46	4.92	1.52	26.63	1.90	7.07	3.24	0.99	
L 5/16" X 2 1/2"	63.50	7.94	6.30	1.88	4.49	2.64	9.48	7.44	35.38	7.87	1.93	55.35	2.41	14.56	5.51	1.24	
L 5/16" X 3"	76.20	7.94	7.90	2.21	5.38	3.04	11.48	9.08	62.90	11.60	2.34	96.98	2.92	24.97	8.21	1.47	
L 5/16" X 4"	101.60	7.94	9.50	2.84	7.18	4.01	15.48	12.20	154.40	21.10	3.15	239.33	3.93	61.60	15.36	2.00	
L 3/8" X 2"	50.80	9.53	6.30	1.63	3.58	2.30	8.77	6.99	19.98	5.74	1.50	30.80	1.87	8.32	3.61	0.99	
L 3/8" X 2 1/2"	63.50	9.53	6.30	1.93	4.49	2.71	11.16	8.78	40.79	9.34	1.91	64.09	2.38	17.06	6.29	1.24	
L 3/8" X 3"	76.20	9.53	7.90	2.26	5.38	3.14	13.61	10.72	73.30	13.60	2.31	112.79	2.89	29.55	9.41	1.47	
L 3/8" X 4"	101.60	9.53	9.50	2.89	7.18	4.03	18.45	14.58	181.90	24.90	3.12	283.03	3.91	73.25	18.17	1.98	
L 3/8" X 5"	127.00	9.53	12.70	3.53	8.96	4.97	23.29	18.30	363.80	39.70	3.96	579.60	4.99	148.00	29.80	2.52	
L 3/8" X 6"	152.40	9.53	12.70	4.16	10.76	5.88	28.13	22.17	640.60	57.80	4.78	1018.60	6.02	262.60	44.70	3.05	
L 1/2" X 3"	76.20	12.70	7.90	2.36	5.38	3.32	17.74	13.99	92.40	17.50	2.29	142.76	2.84	38.29	11.53	1.47	
L 1/2" X 4"	101.60	12.70	9.50	2.99	7.18	4.21	24.19	19.05	231.40	32.30	3.10	361.28	3.86	94.48	22.44	1.98	
L 1/2" X 5"	127.00	12.70	12.70	3.63	8.96	5.12	30.65	24.11	468.30	51.60	3.91	746.50	4.94	190.10	37.20	2.49	
L 1/2" X 6"	152.40	12.70	12.70	4.27	10.76	6.03	37.10	29.17	828.70	75.50	4.72	1326.10	5.97	331.30	54.90	2.99	
L 5/8" X 4"	101.60	15.88	9.50	3.12	7.18	4.39	29.74	23.36	277.20	39.30	3.05	433.71	3.81	115.71	26.35	1.98	
L 5/8" X 6"	152.40	15.88	12.70	4.39	10.76	6.20	45.87	36.01	1005.60	92.80	4.67	1604.80	5.92	406.40	65.60	2.98	
L 3/4" X 6"	152.40	19.05	12.70	4.52	10.76	6.38	54.45	42.71	1171.70	109.10	4.65	1859.20	5.85	484.20	75.90	2.98	
L 1" X 6"	152.40	25.40	12.70	4.72	10.76	6.66	70.97	55.66	1476.00	140.00	4.57	2327.80	5.73	624.20	93.70	2.96	

3

3.15 PERFIL U Ó C ESTÁNDAR AMERICANO

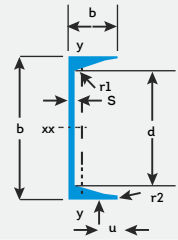

PERFIL C ESTANDAR AMERICANO - CE																	
DIMENSIONES Y PROPIEDADES PARA EL DISEÑO																	
PERFILES CE	DIMENSIONES							AREA	PESO	PROPIEDADES ELÁSTICAS							CONS TORS
	ALTURA		ALA		DISTANCIAS					EJE X-X			EJE Y-Y				
	h	s	b	t	r1	r2	d			Ix	Sx	rx	Iy	Sy	ry	Jt	
DESIGNACIÓN	mm	mm	mm	mm	mm	mm	mm	cm ²	kg/mt	cm ⁴	cm ³	cm	cm ⁴	cm ³	cm	cm ⁴	
C 3 X 4.1	76.20	4.30	35.80	6.90	6.90	2.50	44.00	7.68	6.10	66.40	18.00	2.97	8.32	3.44	1.04	1.12	
C 3 X 5	76.20	6.50	38.00	6.90	6.90	2.50	45.60	9.40	7.44	74.90	19.70	2.84	10.40	3.93	1.04	1.79	
C 3 X 6	76.20	6.50	38.00	6.90	6.90	2.50	45.60	11.30	8.93	87.40	22.90	2.74	12.90	4.42	1.07	3.04	
C 4 X 5.4	101.60	4.60	40.10	7.50	7.10	2.80	68.80	10.10	8.04	158.00	31.10	3.96	13.30	4.75	1.14	1.66	
C 4 X 7.25	101.60	8.10	43.70	7.50	7.10	2.80	68.80	13.70	10.80	187.00	36.90	3.73	18.30	5.73	1.17	3.41	
C 5 X 6.7	127.00	4.80	44.50	8.10	7.40	2.80	91.80	12.60	10.00	308.00	49.20	4.95	20.00	6.23	1.27	2.29	
C 5 X 9	127.00	8.20	47.90	8.10	7.40	2.80	91.80	17.00	13.40	366.00	57.70	4.65	26.60	7.40	1.62	4.54	
C 6 X 8.2	152.40	5.10	48.80	8.70	7.60	3.00	115.00	15.40	12.20	541.00	70.50	5.94	29.10	8.19	1.37	3.12	
C 6 X 10.5	152.40	8.00	51.70	8.70	7.60	3.00	115.00	19.80	15.60	628.00	82.40	5.64	36.20	9.33	1.35	5.45	
C 6 X 13	152.40	11.10	54.80	8.70	7.60	3.00	115.00	24.60	19.30	720.00	95.00	5.41	45.80	10.70	1.35	10.00	
C 6 X 15	152.40	14.30	58.00	8.70	7.60	3.00	115.00	29.40	23.07	813.00	106.70	5.26	53.30	12.10	1.35		
C 7 X 9.8	177.80	5.30	53.10	9.30	7.90	3.30	138.00	18.40	14.60	878.00	98.30	6.91	40.80	10.30	1.50	4.16	
C 7 X 12.25	177.80	8.00	55.70	9.30	7.90	3.30	138.00	23.10	18.20	1002.00	113.00	6.58	50.00	11.60	1.47	6.70	
C 7 X 14.75	177.80	10.60	58.40	9.30	7.90	3.30	138.00	27.90	22.00	1127.00	126.00	6.37	58.20	12.90	1.45	11.20	
C 8 X 11.5	203.20	5.60	57.40	9.90	8.10	3.30	161.00	21.70	17.10	1344.00	133.00	7.87	54.10	12.90	1.60	5.45	
C 8 X 13.75	203.20	7.70	59.50	9.90	8.10	3.30	161.00	26.10	20.50	1489.00	147.00	7.59	62.40	14.10	1.57	7.78	
C 8 X 18.75	203.20	12.40	64.30	9.90	8.10	3.30	161.00	35.40	27.90	1818.00	179.00	7.16	83.20	16.40	1.52	18.20	
C 8 X 21.25	203.20	14.80	67.00	9.90	8.10	3.30	159.00	40.30	31.62	1988.00	195.70	7.02	93.70	18.20	1.52		
C 9 X 13.4	228.60	5.80	61.70	10.50	8.40	3.60	184.00	25.10	19.90	1969.00	172.00	8.86	74.90	15.90	1.70	7.03	
C 9 X 15	228.60	7.20	63.10	10.50	8.40	3.60	184.00	28.30	22.30	2109.00	185.00	8.64	79.00	16.40	1.70	8.70	
C 9 X 20	228.60	11.40	67.30	10.50	8.40	3.60	184.00	37.80	29.80	2521.00	221.00	8.18	99.80	19.70	1.65	17.90	
C 10 X 15.3	254.00	6.10	66.00	11.10	8.60	3.60	207.00	28.80	22.80	2785.00	220.00	9.83	95.70	19.70	1.83	8.78	
C 10 X 20	254.00	9.60	69.50	11.10	8.60	3.60	207.00	38.00	29.80	3267.00	257.00	9.27	117.00	21.60	1.75	15.40	
C 10 X 25	254.00	13.40	73.30	11.10	8.60	3.60	207.00	47.30	37.20	3775.00	297.00	8.93	142.00	24.60	1.73	28.70	
C 10 X 30	254.00	17.10	77.00	11.10	8.60	3.60	207.00	56.80	44.60	4287.00	338.00	8.69	167.00	27.50	1.71	50.80	
C 12 X 20.7	304.80	7.10	74.70	12.70	9.70	4.30	252.00	38.90	30.80	5332.00	351.00	11.70	162.00	27.90	2.06	15.40	
C 12 X 25	304.80	9.80	77.40	12.70	9.70	4.30	252.00	47.20	37.20	5970.00	392.00	11.30	187.00	31.10	2.00	22.50	
C 12 X 30	304.80	12.90	80.50	12.70	9.70	4.30	252.00	56.70	44.60	6706.00	441.00	10.90	216.00	34.40	1.95	36.00	
C 15 X 33.9	381.00	10.20	86.40	16.50	12.70	6.11	314.00	63.90	50.40	13010.00	683.00	14.30	341.00	52.40	2.31	42.00	
C 15 X 40	381.00	13.20	89.40	16.50	12.70	6.11	314.00	75.50	59.50	14410.00	757.00	13.80	387.00	55.70	2.26	60.80	
C 15 X 50	381.00	18.20	94.40	16.50	12.70	6.11	314.00	94.40	74.40	16700.00	878.00	13.30	466.00	62.20	2.21	111.00	

3

3.16 PERFIL I ESTÁNDAR AMERICANO - S

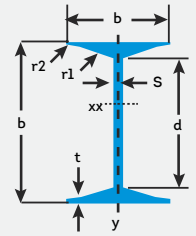

PERFIL I ESTANDAR AMERICANO - S																
PERFILES S	Dimensiones y propiedades para el diseño															
	DIMENSIONES					AREA	PESO	PROPIEDADES ELASTICAS						MODULO PLASTICO		CONS TORS
	ALTIMA		ALA		d			EJE X-X			EJE Y-Y			Zx	Zy	
DESIGNACIÓN	h	s	b	t		d	cm ²	kg/mt	Ix	Sx	rx	Iy	Sy	ry	cm ³	cm ³
	mm	mm	mm	mm	mm	cm ²	kg/mt	cm ⁴	cm ³	cm	cm ⁴	cm ³	cm	cm ³	cm ³	cm ⁴
S 3 x 5.7	76.00	4.32	59.18	6.60	41.00	10.80	8.50	105.00	27.50	3.12	18.94	6.40	1.33	32.00	10.70	1.66
S 3 x 7.5	76.00	8.86	63.73	6.60	41.00	14.30	11.20	122.00	32.00	2.92	24.40	7.70	1.31	38.73	13.54	3.75
S 4 x 5.6	100.00	4.50	50.00	6.80	64.00	10.60	8.32	171.00	34.20	4.01	12.20	4.88	1.07	39.67	8.83	1.27
S 4 x 7.7	102.00	4.90	67.64	7.44	64.00	14.60	11.50	253.00	49.80	4.17	31.80	9.40	1.48	57.32	15.80	2.91
S 4 x 9.5	102.00	8.28	71.02	7.44	64.00	18.00	14.10	283.00	55.60	3.96	37.60	10.60	1.45	66.20	18.52	5.00
S 5 x 7.5	120.00	5.10	58.00	7.70	86.00	14.20	11.20	329.00	54.70	4.81	25.16	7.41	1.33	63.73	13.54	2.16
S 5 x 10.0	127.00	5.44	76.30	8.28	86.00	19.00	14.90	512.00	80.60	5.21	50.78	13.30	1.63	92.91	22.45	4.58
S 5 x 14.75	127.00	12.55	83.41	8.28	86.00	28.00	22.00	633.00	99.80	4.75	69.51	16.60	1.57	121.60	30.81	1.33
S 6 x 12.0	160.00	6.30	74.00	9.50	108.00	22.80	17.90	938.00	117.00	6.41	64.45	14.80	1.68	136.00	27.15	5.24
S 6 x 12.5	152.00	5.89	84.63	9.12	108.00	23.70	18.60	920.00	120.80	6.22	75.75	17.90	1.79	138.80	30.32	7.08
S 6 x 17.25	152.00	11.81	90.55	9.12	108.00	32.70	25.70	1.095.00	143.70	5.79	96.15	21.30	1.71	173.70	38.67	15.40
S 7 x 15.3	178.00	6.40	93.01	9.96	130.00	29.00	22.80	1.528.00	172.10	7.26	110.00	23.60	1.95	198.30	40.00	9.90
S 7 x 20.0	178.00	11.43	98.04	9.96	130.00	37.90	29.80	1.765.00	198.30	6.83	132.00	26.90	1.86	237.61	48.51	18.73
S 8 x 17.4	200.00	7.50	90.00	11.30	152.00	33.50	26.30	2.148.00	214.00	8.01	137.90	26.00	2.03	249.60	47.94	10.70
S 8 x 18.4	203.00	6.88	101.63	10.82	152.00	34.90	27.40	2.397.00	236.00	8.28	155.00	30.50	2.11	270.40	51.78	14.15
S 8 x 23.0	203.00	11.20	105.94	10.82	152.00	43.70	34.20	2.701.00	265.50	7.87	179.00	33.90	2.03	316.27	60.30	22.89
S 9 x 21.8	229.00	7.40	110.00	11.60	178.00	40.70	32.44	3.535.00	309.30	9.32	214.80	39.10	2.29	355.30	72.90	13.84
S 10 x 25.4	254.00	7.90	118.39	12.47	197.00	48.10	37.80	5.161.00	404.80	10.34	283.00	47.70	2.42	465.40	78.60	24.97
S 10 x 35.0	254.00	15.09	125.58	12.47	197.00	66.50	52.10	6.119.00	481.80	9.60	348.00	55.40	2.29	580.10	101.96	53.70
S 12 x 31.8	305.00	8.89	127.00	13.82	244.00	60.30	47.30	9.074.00	596.50	12.27	390.00	61.30	2.54	688.26	104.88	37.46
S 12 x 35.0	305.00	10.87	128.98	13.82	244.00	66.50	52.10	9.532.00	626.00	12.00	411.00	63.70	2.49	734.14	111.27	44.95
S 12 x 40.8	305.00	11.73	133.40	16.74	232.00	77.40	60.70	11.321.00	744.00	12.11	566.00	84.60	2.69	870.00	145.00	73.26
S 12 x 50.0	305.00	17.45	139.11	16.74	232.00	94.80	74.40	12.695.00	832.50	11.56	653.00	94.10	2.62	1.003.00	168.80	117.38
S 15 x 42.9	381.00	10.44	139.73	15.80	311.00	81.30	63.80	18.606.00	976.70	15.11	599.00	85.70	2.72	1.136.00	147.81	64.10
S 15 x 50.0	381.00	13.97	143.26	15.80	311.00	94.80	74.40	20.229.00	1.062.00	14.61	653.00	91.30	2.62	1.263.00	163.38	88.24
S 18 x 54.7	457.00	11.71	152.43	17.55	381.00	104.00	81.40	33.465.00	1.465.00	17.96	866.00	113.70	2.90	1.721.00	198.28	98.65
S 18 x 70.0	457.00	18.06	158.78	17.55	381.00	133.00	104.20	38.543.00	1.688.00	17.04	1.003.00	127.00	2.74	2.048.00	236.00	172.24
S 20 x 66.0	508.00	12.83	158.88	20.19	425.00	125.00	98.20	49.532.00	1.950.00	19.89	1.153.00	145.00	3.02	2.294.00	251.00	149.00
S 20 x 75.0	508.00	16.13	162.18	20.19	425.00	142.00	112.00	53.278.00	2.098.00	19.35	1.240.00	152.70	2.95	2.507.00	274.00	191.00
S 20 x 86.0	514.00	16.76	179.32	23.37	425.00	163.00	128.00	65.765.00	2.540.00	20.00	1.948.00	218.00	3.45	3.000.00	377.00	276.40
S 20 x 96.0	514.00	20.32	182.88	23.37	425.00	182.00	143.00	69.511.00	2.704.00	19.58	2.089.00	228.00	3.38	3.245.00	408.00	349.20
S 24 x 80.0	607.00	12.70	177.80	22.10	521.00	152.00	119.00	87.409.00	2.868.00	24.05	1.756.00	198.00	3.40	3.343.00	339.00	203.00
S 24 x 90.0	607.00	15.88	180.98	22.10	521.00	171.00	134.00	93.652.00	3.064.00	23.39	1.869.00	206.00	3.30	3.638.00	365.00	251.40
S 24 x 100.0	607.00	18.92	184.02	22.10	521.00	189.00	149.00	99.479.00	3.261.00	22.91	1.985.00	216.00	3.23	3.933.00	392.00	316.00
S 24 x 106.0	622.00	15.75	200.00	27.69	521.00	201.00	158.00	122.372.00	3.933.00	24.66	3.209.00	321.00	4.00	4.572.00	544.00	420.40
S 24 x 121.0	622.00	20.32	204.47	27.69	521.00	230.00	180.00	131.529.00	4.228.00	23.95	3.467.00	339.00	3.89	5.014.00	593.00	532.80

3

3.17 PERFIL H AMERICANO DE ALA ANCHA O WF

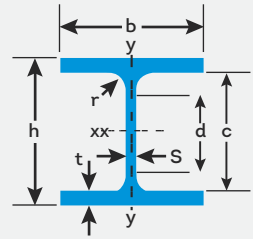

PERFIL H AMERICANO DE ALA ANCHA - WF																		
PERFILES WF		Dimensiones y propiedades para el diseño																
DESIGNACIÓN	DIMENSIONES							AREA cm ²	PESO kg/ mt	PROPIEDADES ELÁSTICAS						MODULO PLÁSTICO		CONS TORS Jt cm ⁴
	ALTURA		ALA		DISTANCIAS					EJE X-X			EJE Y-Y			Zx	Zy	
	h	s	b	t	r	c	d			Ix	Sx	rx	Iy	Sy	ry	cm ³	cm ³	
mm	mm	mm	mm	mm	mm	mm	cm ²	kg/ mt	cm ⁴	cm ³	cm	cm ⁴	cm ³	cm	cm ³	cm ³	cm ⁴	
WF 4 X 13	102.00	6.50	100.00	9.40	6.00	83.20	71.20	24.50	19.35	441.00	86.40	4.24	157.00	31.40	2.53	99.50	48.00	6.90
WF 4 X 13.8	102.00	8.00	102.00	9.40	6.00	83.20	71.20	26.10	20.54	456.00	89.40	4.18	167.00	32.70	2.53	104.00	50.40	8.13
WF 4 X 16.3	107.00	7.90	100.00	12.00	6.00	83.00	71.00	30.90	24.26	587.00	110.00	4.36	200.00	40.10	2.55	129.00	61.50	13.70
WF 5 X 16	127.00	6.10	127.00	9.10	8.00	108.80	92.80	30.30	23.81	886.00	139.00	5.41	311.00	49.00	3.20	157.00	74.70	8.10
WF 5 X 19	131.00	6.90	128.00	10.90	8.00	109.00	93.20	36.00	28.28	1.099.00	168.00	5.53	381.00	59.60	3.26	191.00	90.90	13.40
WF 6 X 9	150.00	4.30	100.00	5.50	6.00	139.00	127.00	17.30	13.50	685.50	91.40	6.29	91.80	18.36	2.30	102.40	28.26	1.74
WF 6 X 12	153.00	5.80	102.00	7.10	6.00	138.40	126.40	22.90	18.00	915.90	122.10	6.33	125.90	25.37	2.36	138.60	39.29	3.86
WF 6 X 16	160.00	6.60	102.00	10.30	6.00	139.40	127.40	30.60	24.00	1.342.00	167.80	6.63	182.60	35.80	2.45	191.50	55.24	9.35
WF 6 X 15	152.00	5.80	152.00	6.60	6.00	138.80	126.80	28.40	22.32	1.205.00	159.00	6.51	387.00	50.90	3.69	176.00	77.50	4.31
WF 6 X 20	157.00	6.60	153.00	9.30	6.00	138.40	126.40	37.90	29.76	1.714.00	218.00	6.73	556.00	72.60	3.83	244.00	111.00	10.20
WF 6 X 25	162.00	8.10	154.00	11.60	6.00	138.80	126.80	47.30	37.20	2.219.00	274.00	6.85	707.00	91.80	3.87	310.00	140.00	19.50
WF 8 X 10	200.00	4.30	100.00	5.20	8.00	189.60	173.60	19.10	15.00	1.280.00	128.00	8.18	86.89	17.38	2.13	145.20	27.10	1.93
WF 8 X 13	203.00	5.80	102.00	6.50	8.00	190.00	174.00	24.80	19.30	1.662.00	163.70	8.17	115.40	22.63	2.15	188.10	35.69	3.99
WF 8 X 15	206.00	6.20	102.00	8.00	8.00	190.00	174.00	28.60	22.50	2.004.00	194.50	8.36	142.00	27.85	2.22	222.80	43.72	5.97
WF 8 X 14	203.00	5.00	133.00	6.40	8.00	190.20	174.20	27.08	21.00	1.980.00	195.10	8.55	251.30	37.78	3.05	217.70	58.03	3.74
WF 8 X 18	207.00	5.80	133.00	8.40	8.00	190.20	174.20	33.90	26.79	2.585.00	250.00	8.73	330.00	49.60	3.12	279.00	76.20	7.31
WF 8 X 21	210.00	6.40	134.00	10.20	8.00	189.60	173.60	40.00	31.25	3.124.00	299.00	8.86	410.00	61.10	3.20	336.00	93.80	12.10
WF 8 X 24	201.00	6.20	165.00	10.20	10.00	180.60	160.60	45.70	35.72	3.437.00	342.00	8.67	764.00	92.60	4.09	379.00	141.00	14.50
WF 8 X 28	205.00	7.20	166.00	11.80	10.00	181.40	161.40	53.10	41.67	4.086.00	399.00	8.77	900.00	108.00	4.12	445.00	165.00	22.30
WF 8 X 31	203.00	7.20	203.00	11.00	10.00	181.00	161.00	58.60	46.13	4.543.00	448.00	8.81	1.535.00	151.00	5.12	495.00	229.00	22.20
WF 8 X 35	206.00	7.90	204.00	12.60	10.00	180.80	160.80	66.50	52.09	5.270.00	512.00	8.90	1.784.00	175.00	5.18	569.00	266.00	32.50
WF 8 X 40	210.00	9.10	205.00	14.20	10.00	181.60	161.60	75.60	59.53	6.111.00	582.00	8.99	2.040.00	199.00	5.20	653.00	303.00	46.80
WF 8 X 48	216.00	10.20	206.00	17.40	10.00	181.20	161.20	91.00	71.43	7.660.00	709.00	9.17	2.537.00	246.00	5.28	803.00	375.00	82.10
WF 8 X 58	222.00	13.00	209.00	20.60	10.00	180.80	160.80	110.00	86.31	9.469.00	853.00	9.26	3.138.00	300.00	5.33	981.00	458.00	141.00
WF 8 X 67	229.00	14.50	210.00	23.70	10.00	181.60	161.60	127.00	99.71	11.330.00	989.00	9.45	3.664.00	349.00	5.38	1.149.00	533.00	211.00
WF 10 X 12	251.00	4.80	101.00	5.30	8.00	240.40	224.40	22.80	17.90	2.252.00	179.50	9.92	91.34	18.09	2.00	207.80	28.67	2.50
WF 10 X 15	254.00	5.80	102.00	6.90	8.00	240.20	224.20	28.50	22.30	2.901.00	228.40	10.06	122.60	24.03	2.07	264.60	38.20	4.68
WF 10 X 17	257.00	6.10	102.00	8.40	8.00	240.20	224.20	32.20	25.30	3.430.00	266.90	10.30	149.20	29.25	2.15	307.50	46.20	6.77
WF 10 X 19	260.00	6.40	102.00	10.00	8.00	240.00	224.00	36.30	28.40	3.998.00	307.50	10.51	177.50	34.81	2.21	352.90	54.71	9.80
WF 10 X 16	253.00	5.00	145.00	6.40	8.00	240.20	224.20	31.12	24.00	3.477.00	274.80	10.57	325.60	44.90	3.23	307.50	69.02	4.16
WF 10 X 22	258.00	6.10	146.00	9.10	8.00	239.80	223.80	41.70	32.74	4.895.00	379.00	10.80	473.00	64.70	3.36	425.00	99.50	10.00
WF 10 X 26	262.00	6.60	147.00	11.20	8.00	239.60	223.60	49.30	38.69	6.014.00	459.00	11.00	594.00	80.80	3.47	514.00	124.00	17.00
WF 10 X 30	266.00	7.60	148.00	13.00	8.00	240.00	224.00	57.30	44.65	7.115.00	535.00	11.10	703.00	95.10	3.50	603.00	146.00	26.40
WF 10 X 33	247.00	7.40	202.00	11.00	13.00	225.00	199.00	62.50	49.11	7.069.00	572.00	10.60	1.513.00	150.00	4.92	634.00	228.00	24.50
WF 10 X 39	252.00	8.00	203.00	13.50	13.00	225.00	199.00	74.30	58.04	8.736.00	693.00	10.80	1.884.00	186.00	5.04	771.00	283.00	41.10
WF 10 X 45	257.00	8.90	204.00	15.70	13.00	225.60	199.60	85.60	66.97	10.360.00	807.00	11.00	2.224.00	218.00	5.10	902.00	332.00	62.60
WF 10 X 49	253.00	8.60	254.00	14.20	13.00	224.60	198.60	92.90	72.92	11.280.00	892.00	11.00	3.880.00	306.00	6.46	986.00	463.00	57.80
WF 10 X 54	256.00	9.40	255.00	15.60	13.00	224.80	198.80	102.00	80.36	12.570.00	982.00	11.10	4.314.00	338.00	6.50	1.091.00	513.00	76.20
WF 10 X 60	260.00	10.70	256.00	17.30	13.00	225.40	199.40	114.00	89.29	14.260.00	1.097.00	11.20	4.841.00	378.00	6.51	1.227.00	575.00	105.00

3

3.17 PERFIL H AMERICANO DE ALA ANCHA O WF

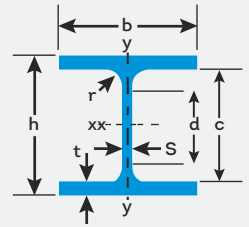

PERFIL H AMERICANO DE ALA ANCHA - WF																		
PERFILES WF	DIMENSIONES Y PROPIEDADES PARA EL DISEÑO																	
	DESIGNACIÓN	DIMENSIONES						AREA	PESO	PROPIEDADES ELASTICAS						MODULO PLASTICO		CONS TORS
		ALTA			DISTANCIAS					EJE X-X			EJE Y-Y			Zx	Zy	Jt
		h	s	b	t	r	c			d	Ix	Sx	rx	Iy	Sy	ry	cm ³	cm ³
mm	mm	mm	mm	mm	mm	mm	cm ²	kg/mt	cm ⁴	cm ³	cm	cm ⁴	cm ³	cm	cm ³	cm ³	cm ⁴	
WF 30 x 173	773.00	16.60	381.00	27.10	17.00	718.80	684.80	328.00	257.45	341900.00	8.845.00	32.30	25.010.00	1.313.00	8.73	9934.00	2.019.00	643.00
WF 30 x 191	779.00	18.00	382.00	30.10	17.00	718.80	684.80	362.00	284.24	381500.00	9.794.00	32.50	28.000.00	1.466.00	8.80	11020.00	2.258.00	866.00
WF 30 x 211	786.00	19.70	384.00	33.40	17.00	719.20	685.20	401.00	314.00	427700.00	10.880.00	32.70	31.570.00	1.644.00	8.88	12290.00	2.536.00	1172.00
WF 30 x 235	795.00	21.10	382.00	38.10	17.00	718.80	684.40	445.00	349.72	485700.00	12.220.00	33.00	35.460.00	1.856.00	8.92	13830.00	2.863.00	1662.00
WF 30 x 261	803.00	23.60	385.00	41.90	17.00	719.20	685.20	495.00	388.41	544000.00	13.550.00	33.20	39.940.00	2.075.00	8.98	15420.00	3.209.00	2237.00
WF 30 x 292	813.00	25.90	387.00	47.00	17.00	719.00	685.00	552.00	434.54	617700.00	15.190.00	33.40	45.510.00	2.352.00	9.08	17370.00	3.644.00	3117.00
WF 30 x 326	823.00	29.00	390.00	52.10	17.00	718.80	684.80	617.00	485.14	697600.00	16.950.00	33.60	51.660.00	2.649.00	9.15	19500.00	4.118.00	4276.00
WF 30 x 357	833.00	31.50	393.00	56.90	17.00	719.20	685.20	676.00	531.28	775500.00	18.620.00	33.90	57.760.00	2.939.00	9.24	21520.00	4.577.00	5567.00
WF 30 x 391	843.00	34.50	396.00	62.00	17.00	719.00	685.00	742.00	581.87	860400.00	20.410.00	34.10	64.430.00	3.254.00	9.32	23720.00	5.080.00	7238.00
WF 30 x 433	855.00	38.10	399.00	68.10	17.00	718.80	684.80	820.00	644.38	964400.00	22.560.00	34.30	72.440.00	3.631.00	9.40	26390.00	5.687.00	9634.00
WF 30 x 477	869.00	41.40	403.00	74.90	17.00	719.20	685.20	904.00	709.86	1086000.00	24.990.00	34.70	82.140.00	4.077.00	9.53	29410.00	6.396.00	12780.00
WF 30 x 526	883.00	45.50	407.00	82.00	17.00	719.00	685.00	997.00	782.78	1218500.00	27.600.00	35.00	92.720.00	4.556.00	9.64	32700.00	7.170.00	16860.00
WF 30 x 581	899.00	50.00	411.00	89.90	17.00	719.20	685.20	1101.00	864.62	1372500.00	30.530.00	35.30	104.800.00	5.099.00	9.76	36450.00	8.050.00	22310.00
WF 33 x 118	835.00	14.00	292.00	18.80	18.00	797.40	761.40	224.00	175.60	246400.00	5.901.00	33.10	7.823.00	536.00	5.91	6.816.00	844.00	227.00
WF 33 x 130	840.00	14.70	292.00	21.70	18.00	796.60	760.60	247.00	193.46	278400.00	6.630.00	33.60	9.029.00	618.00	6.05	7.627.00	971.00	310.00
WF 33 x 141	846.00	15.40	293.00	24.40	18.00	797.20	761.20	269.00	209.83	310700.00	7.346.00	34.00	10.260.00	700.00	6.18	8.430.00	1.093.00	409.00
WF 33 x 152	851.00	16.10	294.00	26.80	18.00	797.40	761.40	289.00	226.20	340100.00	7.992.00	34.30	11.380.00	774.00	6.28	9.163.00	1.213.00	518.00
WF 33 x 169	859.00	17.00	292.00	31.00	18.00	797.00	761.00	319.00	251.00	386500.00	8.999.00	34.79	12.900.00	883.60	6.36	10.304.00	1.383.00	737.60
WF 33 x 201	855.00	18.20	400.00	29.20	18.00	796.60	760.60	381.00	299.12	479400.00	11.210.00	35.50	31.190.00	1.560.00	9.04	12.640.00	2.406.00	863.00
WF 33 x 221	862.00	19.70	401.00	32.40	18.00	797.20	761.20	420.00	328.88	534800.00	12.410.00	37.70	34.880.00	1.739.00	9.12	14.020.00	2.686.00	1155.00
WF 33 x 241	868.00	21.10	403.00	35.60	18.00	796.80	760.80	458.00	358.65	590600.00	13.610.00	35.90	38.900.00	1.931.00	9.22	15.400.00	2.984.00	1507.00
WF 33 x 263	877.00	22.10	401.00	39.90	18.00	797.20	761.20	499.00	391.39	658600.00	15.020.00	36.30	42.960.00	2.143.00	9.28	17.010.00	3.310.00	2021.00
WF 33 x 291	885.00	24.40	404.00	43.90	18.00	797.20	761.20	552.00	433.06	735300.00	16.620.00	36.50	48.350.00	2.394.00	9.36	18.900.00	3.706.00	2702.00
WF33 x 318	893.00	26.40	406.00	48.00	18.00	797.00	761.00	603.00	473.24	812200.00	18.190.00	36.70	53.670.00	2.644.00	9.43	20.770.00	4.100.00	3512.00
WF 33 x 354	903.00	29.50	409.00	53.10	18.00	796.80	760.80	672.00	526.81	914100.00	20.250.00	36.90	60.730.00	2.970.00	9.51	23.250.00	4.620.00	4788.00
WF 33 x 387	913.00	32.00	411.00	57.90	18.00	797.20	761.20	734.00	575.92	1010800.00	22.140.00	37.10	67.230.00	3.271.00	9.57	25.540.00	5.100.00	6190.00
WF 33 x 424	923.00	35.10	414.00	63.00	18.00	797.00	761.00	804.00	630.98	1118600.00	24.240.00	37.30	74.810.00	3.614.00	9.64	28.110.00	5.650.00	8026.00
WF 33 x 468	935.00	38.60	418.00	69.10	18.00	796.80	760.80	888.00	696.46	1252200.00	26.780.00	37.60	84.510.00	4.043.00	9.76	31.250.00	6.340.00	10640.00
WF 33 x 515	949.00	41.90	421.00	75.90	18.00	797.20	761.20	976.00	766.41	1402200.00	29.550.00	37.90	94.900.00	4.508.00	9.86	34.670.00	7.083.00	14030.00
WF 33 x 567	963.00	46.00	425.00	83.10	18.00	796.80	760.80	1076.00	843.79	1569500.00	32.600.00	38.20	107.000.00	5.035.00	9.97	38.490.00	7.934.00	18490.00
WF 33 x 619	977.00	50.00	430.00	89.90	18.00	797.20	761.20	1175.00	921.18	1741700.00	35.650.00	38.50	120.000.00	5.581.00	10.10	42.350.00	8.818.00	23600.00
WF 36 x 135	903.00	15.20	304.00	20.10	19.00	862.80	824.80	256.00	200.90	325200.00	7.203.00	35.60	9.442.00	621.00	6.07	8.356.00	982.00	298.00
WF 36 x 150	911.00	15.90	304.00	23.90	19.00	863.00	825.20	286.00	223.23	376800.00	8.273.00	36.30	11.220.00	738.00	6.27	9.540.00	1163.00	427.00
WF 36 x 160	915.00	16.50	305.00	25.90	19.00	863.20	825.20	304.00	238.11	406400.00	8.883.00	36.60	12.290.00	806.00	6.36	10.230.00	1267.00	519.00
WF 36 x 170	919.00	17.30	306.00	27.90	19.00	863.20	825.20	323.00	252.99	437500.00	9.520.00	36.80	13.370.00	874.00	6.43	10.960.00	1375.00	631.00
WF 36 x 182	923.00	18.40	307.00	30.00	19.00	863.00	825.00	346.00	270.85	471600.00	10.220.00	36.90	14.520.00	946.00	6.48	11.780.00	1491.00	775.00
WF 36 x 194	927.00	19.40	308.00	32.00	19.00	863.00	825.00	368.00	288.70	504500.00	10.880.00	37.00	15.640.00	1.016.00	6.52	12.570.00	1.603.00	930.00
WF 36 x 210	932.00	21.10	309.00	34.50	19.00	863.00	825.00	398.00	312.52	548200.00	11.760.00	37.10	17.040.00	1.103.00	6.54	13.630.00	1.748.00	1171.00

3

3.18 EQUIVALENCIAS ENTRE PERFILES EUROPEOS (IPE, HE, IPN, HD) Y AMERICANOS (WF Y S)

EQUIVALENCIAS ENTRE PERFILES						
EQUIVALENCIAS APROXIMADAS ENTRE PERFILES						
PERFIL WF	PERFIL S	PERFIL HEA	PERFIL HEB	PERFIL IPE	PERFIL IPN	PERFIL HD
NORMA ASTM	NORMA ASTM	NORMA DIN	NORMA DIN	NORMA DIN	NORMA DIN	NORMA ASTM
WF 4 X 13		HEA 100	HEB 100			
WF 4 X 13.8		HEA A 120	HEB 100			
WF 4 X 16.3		HEA 120	HEB 100			
WF 5 X 16		HEA 120, HEA A 140	HEB 120			
WF 5 X 19		HEA 140, HEA A160	HEB 140			
WF 6 X 9	S 6 X 12.2	HEA A 120		IPE 160, IPE 180	IPN 140	
WF 6 X 12		HEA 120, HEA A 140		IPE 180	IPN 160	
WF 6 X 15		HEA 140, HEA A 160				
WF 6 X 20		HEA 160, HEA A 180				
WF 6 X 25		HEA 180	HEB 160			
WF 8 X 10				IPE 180, IPE A 200		
WF 8 X 13				IPE A 200, IPE 200	IPN 180	
WF 8 X 15				IPE 200, IPE A 200	IPN 200	
WF 8 X 18	S 8 X 18.4			IPE 220, IPE A 240		
WF 8 X 21		HEA 180		IPE 240	IPN 220	
WF 8 X 24		HEA A 200, HEA 200		IPE 240		
WF 8 X 28		HEA 200, HEA A 200	HEB 160			
WF 8 X 31		HEA 220	HEB 180			
WF 8 X 35		HEA 220, HEA A 240	HEB 180			
WF 8 X 40		HEA 240	HEB 200			
WF 8 X 48			HEB 220			
WF 8 X 58			HEB 240			HD 210 X 87
WF 8 X 67			HEB 260			HD 210 X 100
WF 10 X 12				IPE A 200, IPE 200		
WF 10 X 15				IPE A 220, IPE 220		
WF 10 X 17				IPE A 240, IPE 240		
WF 10 X 19				IPE A 270, IPE 270		
WF 10 X 22				IPE 270	IPN 240	
WF 10 X 26	S 10 X 25.4			IPE 270, IPE A 300	IPN 260	
WF 10 X 30		HEA A 240, HEA 240		IPE 300		
WF 10 X 33		HEA 240		IPE 300		
WF 10 X 39		HEA 240, HEA A 260				
WF 10 X 45		HEA 260, HEA A 280	HEB 220			
WF 10 X 49		HEA 280	HEB 240			HD 260 X 73
WF 10 X 54		HEA 280, HEA A 300	HEB 260			HD 260 X 80
WF 10 X 60		HEA 300	HEB 260			HD 260 X 89
WF 10 X 68			HEB 280			HD 260 X 101
WF 10 X 77			HEB 300			HD 260 X 115
WF 10 X 88						HD 260 X 131
WF 10 X 100						HD 260 X 149
WF 10 X 112						HD 260 X 167

Nota: La información aquí contenida fue preparada para brindar apoyo técnico a nuestro Departamento Comercial, no debe ser usada sin la supervisión de un profesional competente con conocimiento en diseño de estructuras metálicas.

3

3.18 EQUIVALENCIAS ENTRE PERFILES EUROPEOS (IPE, HE, IPN, HD) Y AMERICANOS (WF Y S).

EQUIVALENCIAS ENTRE PERFILES						
EQUIVALENCIAS APROXIMADAS ENTRE PERFILES						
PERFIL WF	PERFIL S	PERFIL HEA	PERFIL HEB	PERFIL IPE	PERFIL IPN	PERFIL HD
NORMA ASTM	NORMA ASTM	NORMA DIN	NORMA DIN	NORMA DIN	NORMA DIN	NORMA ASTM
WF 12 X 14				IPE A 240, IPE 240		
WF 12 X 16				IPE A 270, IPE 270	IPN 240	
WF 12 X 19				IPE 270, IPE A 300		
WF 12 X 22				IPE A 300, IPE 300		
WF 12 X 26				IPE 300, IPE A 330	IPN 260	
WF 12 X 30	S 12 X 31.8			IPE A 330, IPE 330	IPN 280	
WF 12 X 35	S 12 X 35			IPE 330, IPE A 360	IPN 300	
WF 12 X 40		HEA 240, HEA A 260		IPE 360		
WF 12 X 45		HEA 260, HEA A 280				
WF 12 X 50		HEA 280, HEA A 300				
WF 12 X 53		HEA A 300, HEA 300				
WF 12 X 58		HEA 300, HEA A 320	HEB 260			
WF 12 X 65		HEA 320, HEA A 340	HEB 260			HD 310 X 97
WF 12 X 72		HEA A 340, HEA 340	HEB 280, HEB 300			HD 310 X 107
WF 12 X 79		HEA 340, HEA A 360	HEB 300			HD 310 X 117
WF 12 X 87		HEA 360	HEB 320			HD 310 X 130
WF 12 X 96			HEB 340			HD 310 X 143
WF 12 X 106						HD 310 X 158
WF 12 X 120						HD 310 X 179
WF 12 X 136						HD 310 X 202
WF 12 X 152						HD 310 X 227
WF 12 X 170						HD 310 X 253
WF 12 X 190						HD 310 X 283
WF 12 X 210						HD 310 X 313
WF 12 X 230						HD 310 X 343
WF 12 X 252						HD 310 X 375
WF 12 X 279						HD 310 X 415
WF 12 X 305						HD 310 X 454
WF 12 X 336						HD 310 X 500
WF 14 X 22				IPE A 300, IPE 300		
WF 14 X 26				IPE A 330, IPE 330		
WF 14 X 30				IPE A 360, IPE 360		
WF 14 X 34				IPE 360		
WF 14 X 38				IPE 360		
WF 14 X 43	S 15 X 42.9	HEA 280, HEA A 300		IPE 360, IPE A 400	IPN 340	
WF 14 X 48		HEA 300, HEA A 340		IPE A 400, IPE 400		
WF 14 X 53		HEA A 340, HEA 340		IPE 400, IPE 450	IPN 360	
WF 14 X 61		HEA 340, HEA A 360		IPE 450, IPE A 500		
WF 14 X 68		HEA 340, HEA 360				
WF 14 X 74	S 15 X 50	HEA 360, HEA A 400	HEB 320, HEB 340			
WF 14 X 82		HEA 400	HEB 340, HEB 360			

Nota: La información aquí contenida fue preparada para brindar apoyo técnico a nuestro Departamento Comercial, no debe ser usada sin la supervisión de un profesional competente con conocimiento en diseño de estructuras metálicas.

3

3.18 EQUIVALENCIAS ENTRE PERFILES EUROPEOS (IPE, HE, IPN, HD) Y AMERICANOS (WF Y S)

EQUIVALENCIAS ENTRE PERFILES						
EQUIVALENCIAS APROXIMADAS ENTRE PERFILES						
PERFIL WF	PERFIL S	PERFIL HEA	PERFIL HEB	PERFIL IPE	PERFIL IPN	PERFIL HD
NORMA ASTM	NORMA ASTM	NORMA DIN	NORMA DIN	NORMA DIN	NORMA DIN	NORMA ASTM
WF 14 X 90		HEA 400	HEB 360			HD 360 X 134
WF 14 X 99		HEA 450	HEB 400			HD 360 X 148
WF 14 X 109			HEB 450			HD 360 X 162
WF 14 X 120			HEB 500			HD 360 X 179
WF 14 X 132			HEB 550			HD 360 X 196
WF 14 X 145			HEB 600			HD 400 X 216
WF 14 X 159						HD 400 X 237
WF 14 X 176						HD 400 X 262
WF 14 X 193						HD 400 X 288
WF 14 X 211						HD 400 X 314
WF 14 X 233						HD 400 X 347
WF 14 X 257						HD 400 X 383
WF 14 X 283						HD 400 X 422
WF 14 X 311						HD 400 X 463
WF 14 X 342						HD 400 X 509
WF 14 X 370						HD 400 X 551
WF 14 X 398						HD 400 X 593
WF 14 X 426						HD 400 X 634
WF 14 X 455						HD 400 X 678
WF 14 X 500						HD 400 X 744
WF 14 X 550						HD 400 X 818
WF 14 X 605						HD 400 X 900
WF 14 X 665						HD 400 X 990
WF 14 X 730						HD 400 X 1086
WF 16 X 26				IPE 330, IPE A 360		
WF 16 X 31				IPE 360, IPE A 400		
WF 16 X 36				IPE 360, IPE 400		
WF 16 X 40	S 15 X 42.9			IPE A 400, IPE 400		
WF 16 X 45				IPE A 400, IPE 400		
WF 16 X 50	S 15 X 50			IPE 400, IPE A 450	IPN 360	
WF 16 X 57				IPE A 450, IPE 450	IPN 380	
WF 16 X 67		HEA 360, HEA A 400	HEB 340		IPN 400	
WF 16 X 77		HEA 360, HEA 400				
WF 16 X 89		HEA 400	HEB 360			
WF 16 X 100		HEA 400, HEA 450	HEB 400			
WF 18 X 35				IPE A 400, IPE 400		
WF 18 X 40				IPE 400, IPE A 450		
WF 18 X 46				IPE A 450, IPE 450		
WF 18 X 50				IPE 450		
WF 18 X 55				IPE 450, IPE A 500		
WF 18 X 60				IPE 450, IPE 500		
WF 18 X 65				IPE 500	IPN 400	
WF 18 X 71				IPE 500, IPE 600	IPN 450	

Nota: La información aquí contenida fue preparada para brindar apoyo técnico a nuestro Departamento Comercial, no debe ser usada sin la supervisión de un profesional competente con conocimiento en diseño de estructuras metálicas.

3

3.18 EQUIVALENCIAS ENTRE PERFILES EUROPEOS (IPE, HE, IPN, HD) Y AMERICANOS (WF Y S).

EQUIVALENCIAS ENTRE PERFILES						
EQUIVALENCIAS APROXIMADAS ENTRE PERFILES						
PERFIL WF	PERFIL S	PERFIL HEA	PERFIL HEB	PERFIL IPE	PERFIL IPN	PERFIL HD
NORMA ASTM	NORMA ASTM	NORMA DIN	NORMA DIN	NORMA DIN	NORMA DIN	NORMA ASTM
WF 18 X 76		HEB 400, HEA A 450	HEB 360	IPE 550		
WF 18 X 86		HEA 450	HEB 400	IPE 600		
WF 18 X 97		HEA 450	HEB 450			
WF 18 X 106		HEA 500	HEB 450			
WF 18 X 119		HEA 500, HEA 550	HEB 500			
WF 21 X 44				IPE A 500, IPE 500		
WF 21 X 50				IPE A 500, IPE 500		
WF 21 X 57				IPE 500, IPE A 550		
WF 21 X 62				IPE 550, IPE A 550		
WF 21 X 68				IPE 550		
WF 21 X 73				IPE 550		
WF 21 X 83				IPE 550, IPE 600		
WF 21 X 93				IPE 600		
WF 21 X 101		HEA 450, HEA 500	HEB 500			
WF 21 X 111		HEA 550	HEB 500			
WF 21 X 122		HEA 550, HEA 600	HEB 550			
WF 21 X 132		HEA 600	HEB 550			
WF 21 X 147		HEA 600	HEB 550, HEB 600			
WF 24 X 68				IPE A 600, IPE 600		
WF 24 X 76				IPE 600		
WF 24 X 84				IPE 600		
WF 24 X 94				IPE 600		
WF 24 X 104		HEA 500, HEA 550	HEB 450			
WF 24 X 117		HEA 550	HEB 500			
WF 24 X 131		HEA 600	HEB 550			
WF 24 X 146			HEB 600			
WF 24 X 162			HEB 600			
WF 27 X 84				IPE 600		
WF 27 X 94				IPE 600		
WF 27 X 102				IPE 750 X 146		
WF 27 X 114				IPE 750 X 172		
WF 27 X 146		HEA 700	HEB 650			
WF 27 X 161		HEA 800	HEB 700			
WF 27 X 178		HEA 900	HEB 800			

Nota: La información aquí contenida fue preparada para brindar apoyo técnico a nuestro Departamento Comercial, no debe ser usada sin la supervisión de un profesional competente con conocimiento en diseño de estructuras metálicas.

3











3.18 EQUIVALENCIAS ENTRE PERFILES EUROPEOS (IPE, HE, IPN, HD) Y AMERICANOS (WF Y S)

EQUIVALENCIAS ENTRE PERFILES						
EQUIVALENCIAS APROXIMADAS ENTRE PERFILES						
PERFIL WF	PERFIL S	PERFIL HEA	PERFIL HEB	PERFIL IPE	PERFIL IPN	PERFIL HD
NORMA ASTM	NORMA ASTM	NORMA DIN	NORMA DIN	NORMA DIN	NORMA DIN	NORMA ASTM
WF 30 X 99				IPE 750 X 146		
WF 30 X 108				IPE 750 X 160		
WF 30 X 116				IPE 750 X 173		
WF 30 X 124				IPE 750 X 183		
WF 30 X 132				IPE 750 X 195		
WF 30 X 173		HEA 800	HEB 800			
WF 30 X 191		HEA 900	HEB 900			
WF 30 X 211		HEA 1000	HEB 900			
WF 33 X 118		HEA 700		IPE 750 X 183		
WF 33 X 130		HEA 800		IPE 750 X 195		
WF 33 X 141		HEA 800				
WF 33 X 152		HEA 800				
WF 33 X 201			HEB 900			
WF 33 X 221		HEA 1000				
WF 33 X 241			HEB 1000			
WF 36 X 135		HEA A 900				
WF 36 X 150		HEA 900				
WF 36 X 160		HEA 900				
WF 36 X 170		HEA 900				
WF 36 X 182			HEB 900			
WF 36 X 194			HEB 900			
WF 36 X 210		HEA 1000				
WF 36 X 230			HEB 1000			
WF 36 X 245			HEM 1000			
WF 36 X 260		HE 900 X 396				
WF 36 X 280			HE 1000 X 415			
WF 36 X 300		HE 900 X 471				

Nota: La información aquí contenida fue preparada para brindar apoyo técnico a nuestro Departamento Comercial, no debe ser usada sin la supervisión de un profesional competente con conocimiento en diseño de estructuras metálicas.

3

3.19 RESUMEN DE PERFILES MÁS COMERCIALES

RANGO (ALTURA)	ANGULOS	PERFIL C	PERFIL S	WF	IPN	IPE	HEA	HEB	HD	UPN
Milímetros (Pulg.)										
	(Altura x Ala)	(h x l/p)	(h x l/p)	(h x l/p)	(h-mm)	(h-mm)	(h-mm)	(h-mm)	(h x k/m)	(h-mm)
12<h<19.05 (3/4")	3/4"x1/8,3/16 (2)									
20<h<25.4 (1")	1"x1/8,3/6 (2)									
26<h<31.7 (1 1/4")	1 1/4"x1/8,3/16 (2)									
32<h<38.1 (1 1/2")	1 1/2"x1/8,3/16,1/4 (3)									
39<h<50.8 (2")	2"x1/8,3/16,1/4 (3)									
51<h<63.5 (2 1/2")	2 1/2"x3/16,1/4 (2)									
64<h<76.2 (3")	3"x1/4,5/16,3/8 (3)	3"x3.5, 4.1(2)								
77<h<101.6 (4")	4"x1/4,5/16,3/8,1/2 (4)	4"x4.5, 5.4(2)	4"x5.6	4"x13	80 100	80 100	100	100		80 100
102<h<127 (5")	5"x3/8,1/2 (2)						120	120		
128<h<152.4 (6")	6"x3/8,1/2,5/8,3/4 (4)	6"x8.2	6"x12	6"x15,25 (2)			140	140		
153<h<177.8 (7")					160	160	160	160		160
178<h<203.2 (8")		8"x11.5		8"x18 8"x24 8"x31,40 (2)	200	180 200	180 200	180 200		200
204<h<228.6 (9")						220	220	220		
229<h<254 (10")		10"x15.3		10"x22 10"x39 10"x49,60(2)		240	240	240		
255<h<304.8 (12")		12"x20.7		12"x26,30,35 (3) 12"x50,58 (2) 12"x65,79,96 (3)		270 300	260 280 300	260 280 300		
305<h<355.6 (14")				14"x30 14"x48 14"x68 14"x90,120,145 (3)		330	340	320 340		
356<h<406.4 (16")				16"x40,50 (2) 16"x77		360 400	360 400	360 400	HD 360 x 134 HD 360 x 179 HD 400 x 216	
407<h<457.2 (18")				18"x46 18"x50,76 (2) 21"x50		450	450	450		
458<h<533.4 (21")				21"x68,83 (2) 21"x111		500	500	500		
534<h<609.6 (24")				24"x62 24"x84 24"x104,117, 146 (3)		600	600	600		
TOTALES	27	8	2	40	4	18	19	19	3	4
GENERAL	144									

() Nota: Los parentesis indican el número de referencias por altura, cuando es más de una.

 Los productos sombreados SON de nuestra comercialización habitual.

 Otros productos venta solo bajo pedido, sujeto a entrega del productor.

Nota: Para identificar que productos debían hacer parte del presente resumen, nuestra empresa realizó un análisis basados en su experiencia en el sector. Es posible que en el mercado existan otros elementos de acero de uso estructural que también son comerciales en Colombia pero que no están incluidos en este resumen.



4

***TUBERÍA DE
ACERO CARBÓN***

4

4.0 TUBERÍA DE ACERO CARBÓN PARA CONDUCCIÓN.

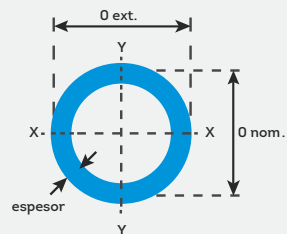

CALIDADES	COMPOSICIÓN QUÍMICA					CARACTERÍSTICAS MECÁNICAS			
	C	Mn	Si	P	S	LÍMITE ELÁSTICAS	RESISTENCIA A LA TRACCIÓN		
API - 5L X 42	0.29	1.35	-	0.04	0.05	42.000 PSI	289 MPA	60.000 PSI	413 MPA
ASTM - A 53 GRA	0.25	0.90	-	0.05	0.06	30.000 PSI	207 MPA	48.000 PSI	331 MPA
ASTM - A 53 GR B	0.30	1.20	-	0.05	0.06	35.000 PSI	241 MPA	60.000 PSI	413 MPA
ASTM - A 106 GR B	0.30	0.29/106	0.1	0.048	0.058	35.000 PSI	241 MPA	60.000 PSI	413 MPA

NOMINAL	DIÁMETRO EXTERIOR		ESPESOR PARED		PESO NOMINAL		WEIGHT CLASS	SCHEDULE
	Pulg.	mm	Pulg.	mm.	L/P	Kg/m		
1/4"	0.540	13.70	0.088	2.24	0.42	0.63	STD	40
1/4"	0.540	13.70	0.019	3.02	0.54	0.80	XS	80
3/8"	0.675	17.20	0.091	2.31	0.57	0.84	STD	40
3/8"	0.675	17.20	0.126	3.20	0.74	1.10	XS	80
1/2"	0.840	21.30	0.109	2.77	0.85	1.27	STD	40
1/2"	0.840	21.30	0.147	3.73	1.09	1.62	XS	80
3/4"	1.050	26.70	0.113	2.87	1.13	1.69	STD	40
3/4"	1.050	26.70	0.154	3.91	1.47	2.20	XS	80
1"	1.315	33.40	0.133	3.38	1.68	2.50	STD	40
1"	1.315	33.40	0.179	4.55	2.17	3.24	XS	80
1 1/4"	1.660	42.20	0.140	3.56	2.27	3.39	STD	40
1 1/4"	1.660	42.20	0.191	4.85	3.00	4.47	XS	80
1 1/2"	1.900	48.30	0.145	3.68	2.72	4.05	STD	40
1 1/2"	1.900	48.30	0.200	5.08	3.63	5.41	XS	80
2"	2.375	60.30	0.154	3.91	3.65	5.44	STD	40
2"	2.375	60.30	0.128	5.54	5.02	7.48	XS	80
2"	2.375	60.30	0.344	8.74	7.46	11.11		160
2 1/2"	2.875	73.00	0.203	5.16	5.79	8.63	STD	40

4

4.0 TUBERÍA DE ACERO CARBÓN PARA CONDUCCIÓN.

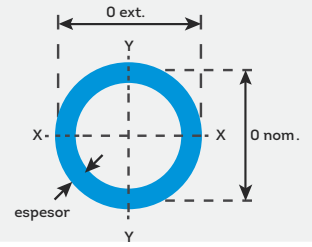

CALIDADES	COMPOSICIÓN QUÍMICA					CARACTERÍSTICAS MECÁNICAS			
	C	Mn	Si	P	S	LÍMITE ELÁSTICAS	RESISTENCIA A LA TRACCIÓN		
API - 5L X 42	0.29	1.35	-	0.04	0.05	42.000 PSI	289 MPA	60.000 PSI	413 MPA
ASTM - A 53 GR A	0.25	0.90	-	0.05	0.06	30.000 PSI	207 MPA	48.000 PSI	331 MPA
ASTM - A 53 GR B	0.30	1.20	-	0.05	0.06	35.000 PSI	241 MPA	60.000 PSI	413 MPA
ASTM - A 106 GR B	0.30	0.29/106	0.1	0.048	0.058	35.000 PSI	241 MPA	60.000 PSI	413 MPA

DIÁMETRO			ESPESOR PARED		PESO NOMINAL		WEIGHT CLASS	SCHEDULE
NOMINAL	EXTERIOR		Pulg.	mm.	L/P	Kg/m		
Pulg.	Pulg.	mm	Pulg.	mm.	L/P	Kg/m		
2 1/2"	2.875	73.00	0.276	7.01	7.66	11.41	XS	80
2 1/2"	2.875	73.00	0.375	9.53	10.01	14.92		160
3"	3.500	88.90	0.216	5.49	7.58	11.29	STD	40
3"	3.500	88.90	0.300	7.62	10.25	15.27	XS	80
3"	3.500	88.90	0.438	11.13	14.32	21.35		160
4"	4.500	114.30	0.237	6.02	10.79	16.07	STD	40
4"	4.500	114.30	0.337	8.56	14.98	22.32	XS	80
4"	4.500	114.30	0.531	13.49	22.51	33.54		160
5"	5.563	141.30	0.258	6.55	14.62	21.77	STD	40
5"	5.563	141.30	0.375	9.53	20.78	30.97	XS	80
5"	5.563	141.30	0.625	15.88	32.96	49.11		160
6"	6.625	168.30	0.280	7.11	18.97	28.26	STD	40
6"	6.625	168.30	0.432	10.97	28.57	42.56	XS	80
6"	6.625	168.30	0.719	18.26	45.35	67.56		160
8"	8.625	219.10	0.322	8.18	28.55	42.55	STD	40
8"	8.625	219.10	0.500	12.70	43.39	64.64	XS	80
8"	8.625	219.10	0.906	23.01	74.69	111.27		160
10"	10.750	273.10	0.365	9.27	40.48	60.31	STD	40
10"	10.750	273.10	0.594	15.09	64.43	96.01	XS	80
12"	12.750	323.90	0.406	10.31	53.52	79.70	STD	40
14"	14.875	377.90	0.440	11.13	63.51	94.49	STD	40
16"	17.000	431.80	0.500	12.70	82.86	123.29	STD	40
18"	19.125	485.80	0.506	14.27	104.78	155.91	STD	40
20"	21.185	538.20	0.590	15.08	123.03	183.05	STD	40
24"	25.375	644.50	0.690	17.48	171.49	255.14	STD	40

4

4.1 TUBERÍA DE ACERO ESTRUCTURAL REDONDA.

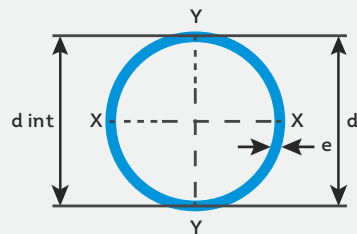

REFERENCIA DIÁMETRO NOMINAL	REFERENCIA DIÁMETRO REAL				Peso teórico calculado	Área A	FLEXIÓN			MÓDULO PLÁSTICO	MOMENTO DE INERCIA TORCIONAL	CONSTANTE DE CORTE TORCIONAL	UNIDAD DE EMPAQUE
		Diámetro Exterior	Diámetro Interior	Espesor			I	S	r	Z			
Tubería Circular		d [mm]	d int [mm]	t [mm]	[kg / m]	[mm ²]	[mm ⁴]	[mm ³]	[mm]	[mm ³]	J [mm ⁴]	C [mm ³]	
1-1/2"	1.89"	48.0	45.0	1.50	10.32	204.25	55503,5	2312,6	16,48	3030,9	111007,0	4759,48	91
1-1/2"	1.89"	48.0	44.0	2.00	13,61	269,61	71863,9	2994,3	16,33	3961,9	143727,8	6219,97	
1-1/2"	1.89"	48.0	42.0	3.00	19,98	396,27	101629,2	4234,5	16,01	5709,8	203258,4	8957,63	61
2"	2.36"	60.0	56.0	2.00	17,16	339,73	143695,2	4789,8	20,57	6289,4	287390,3	9876,04	
2"	2.36"	60.0	55.0	2.50	21,27	421,27	175449,0	5848,3	20,41	7738,1	350898,0	12148,37	37
2-1/2"	2.87"	73.0	69.0	2.00	21,01	415,70	263154,7	7209,7	25,16	9415,4	526309,5	14786,34	
2-1/2"	2.87"	73.0	68.0	2.50	26,08	516,22	322663,6	8840,1	25,00	11617,5	645327,3	18242,08	37
3"	3-1/2"	89.0	85.0	2.00	25,75	509,19	483529,9	10865,8	30,82	14125,8	967059,8	22185,43	
3"	3-1/2"	89.0	84.0	2.50	32,00	633,09	594944,9	13369,5	30,66	17470,9	1189889,9	27436,62	37
3"	3-1/2"	89.0	83.0	3.00	38,18	755,63	702735,1	15791,8	30,50	20743,0	1405470,2	32571,62	
3"	3-1/2"	89.0	81.0	4.00	50,31	996,64	907757,8	20399,1	30,18	27071,5	1815515,6	42496,90	19
4"	4-1/2"	114,3	109,3	2,50	41,36	817,89	1282428,8	22439,7	39,60	29156,0	2564857,5	45791,51	
4"	4-1/2"	114,3	108,3	3,00	49,41	977,39	1520118,1	26598,7	39,44	34699,4	3040236,2	54494,38	19
4"	4-1/2"	114,3	106,3	4,00	65,28	1292,32	1977533,3	34602,5	39,12	45505,1	3955066,5	71452,26	
4"	4-1/2"	114,3	102,3	6,00	96,15	1905,87	2823351,4	49402,5	38,49	66013,7	5646702,8	103603,15	2
---	6"	152,4	144,4	4,00	87,83	1737,58	4804323,8	63048,9	52,58	82250,5	9608647,6	129171,86	
---	6"	152,4	140,4	6,00	129,98	2573,77	6945069,6	91142,6	51,95	120341,0	13890139,2	188940,26	
---	6"	152,4	136,4	8,00	170,93	3388,22	8923184,6	117102,2	51,32	156477,0	17846369,2	245577,84	2
8"	8-5/8"	219,1	209,1	5,00	158,38	3132,41	18011226,4	164429,8	75,83	21381,6	36022452,9	335833,23	
8"	8-5/8"	219,1	207,1	6,00	189,17	3742,59	21338003,5	194800,9	75,51	254395,0	42676006,9	399511,69	2
8"	8-5/8"	219,1	203,1	8,00	249,86	4946,64	27728839,7	253144,7	74,87	333370,2	55457679,3	523441,07	
8"	8-5/8"	219,1	199,1	10,00	309,37	6128,96	33779775,8	308385,5	74,24	409519,7	67559551,6	642850,94	2
10"	10-3/4"	273,1	259,1	7,00	275,57	5451,21	48438094,5	354792,9	94,26	462585,6	96876188,9	726483,33	
10"	10-3/4"	273,1	255,1	9,00	351,64	6959,80	61007440,9	446859,1	93,63	586560,0	122014881,8	921059,29	2
10"	10-3/4"	273,1	249,1	12,00 *	463,53	9181,91	78862174,0	577639,1	92,68	765887,2	157724347,9	1202325,07	
12"	12-3/4"	323,9	307,9	8,00	373,89	7395,59	92602663,4	571886,1	111,90	744995,0	185205326,8	1170019,81	2
12"	12-3/4"	323,9	303,9	10,00	464,40	9190,15	113760469,6	702550,4	111,26	920426,0	227520939,1	1445380,54	
12"	12-3/4"	323,9	299,9	12,00 *	553,73	10962,97	134158720,9	828523,8	110,62	1091632,7	268317441,8	1714004,89	

Metaltub Acesco, cumplen con norma ASTM A500 Grado C. Resistencia a la fluencia mín 315 Mpa (46.000 psi)

* Tubos suministrados en bajo norma ASTM A500 Grado A. Resistencia a la fluencia mín 230 Mpa (33.000 psi)

LARGO DE TUBOS MÁS COMERCIALES



4

4.2 TUBERÍA DE ACERO ESTRUCTURAL CUADRADA.

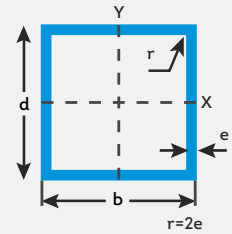

REFERENCIA	REAL		ESPESOR PARED	PESO TEÓRICO CALCULADO	ÁREA A	FLEXIÓN			MÓDULO PLÁSTICO	MOMENTO DE INERCIA TORCIONAL	CONSTANTE DE CORTE TORCIONAL	UNIDAD DE EMPAQUE
	d [mm]	b [mm]				I _x	S _x	r _x	Z _x			
Tubería Cuadrada	d [mm]	b [mm]	e [mm]	[kg / m]	[mm ²]	[mm ⁴]	[mm ³]	[mm]	[mm ³]	J [mm ⁴]	C [mm ³]	
50 x 50	50	50	1,50	2,24	281,3	101366,5	4054,7	19,66	4723,7	160183,2	6580,74	100
50 x 50	50	50	2,00	2,93	366,8	128768,8	5150,8	19,39	6076,1	207506,3	8596,09	
50 x 50	50	50	2,50	3,60	448,2	153122,5	6124,9	19,12	7319,6	251938,8	10520,46	
60 x 60	60	60	2,00	3,56	446,8	229847,7	7661,6	23,48	8962,6	365542,6	12549,71	100
60 x 60	60	60	2,50	4,39	548,2	275865,8	9195,5	23,22	10870,7	446052,3	15419,24	
60 x 60	60	60	3,00	5,19	645,4	317514,9	10583,8	22,95	12648,2	522420,3	18179,36	
70 x 70	70	70	2,00	4,19	526,8	373395,6	10668,4	27,57	12407,1	588463,2	17247,32	64
70 x 70	70	70	2,50	5,17	648,2	451016,8	12886,2	27,31	15119,3	720622,4	21248,01	
70 x 70	70	70	3,00	6,13	765,4	522589,2	14931,1	27,04	17678,1	847043,8	25122,00	
90 x 90	90	90	2,50	6,74	848,2	995742,5	22127,6	35,49	25708,9	1566932,5	35695,56	36
90 x 90	90	90	3,00	8,01	1005,4	1163603,9	25857,9	35,22	30248,9	1850559,5	42355,27	
100 x 100	100	100	2,50	7,53	948,2	1383917,1	27678,3	39,57	32050,0	2166572,5	44314,34	
100 x 100	100	100	3,00	8,96	1125,4	1621864,1	32437,3	39,31	37789,7	2562931,7	52645,90	25
100 x 100	100	100	4,00	11,73	1467,3	2060301,2	41206,0	38,78	48609,0	3320100,2	68768,74	
100 x 100	100	100	6,00	16,98	2101,5	2792252,3	55845,0	37,69	67643,0	4697060,9	98821,79	
120 x 120	120	120	4,00	14,25	1787,3	3677562,9	61292,7	46,97	71701,0	5848682,0	100397,67	9
135 x 135	135	135	4,00	16,13	2027,3	5329923,9	78961,8	53,10	91949,5	8416637,9	128025,37	9
135 x 135	135	135	6,00	23,58	2941,5	7438252,5	110196,3	52,04	130737,4	12095905,5	186253,69	4
150 x 150	150	150	4,00	18,01	2267,3	7414726,0	98863,0	59,23	114709,0	11643882,0	159001,06	
150 x 150	150	150	6,00	26,40	3301,5	10430274,8	139070,3	58,18	164055,4	16808007,0	232094,51	
150 x 150	150	150	9,00	38,21	4728,3	14135777,2	188477,0	56,53	228295,0	23778870,6	333523,54	2
200 x 200	200	200	5,00	30,11	3792,7	22142673,8	221426,7	79,14	256400,3	34665159,2	354514,70	
200 x 200	200	200	7,00	41,43	5193,7	29556279,9	295562,8	78,10	346471,6	47158128,6	486381,97	
200 x 200	200	200	9,00	52,34	6528,3	36178243,1	361782,4	77,03	429529,2	58900089,8	612462,16	2
200 x 200	200	200	12,00 *	67,93	8405,9	44676036,6	446760,4	75,38	541143,8	75152973,7	790574,31	
250 x 250	250	250	9,00	66,47	8328,3	73861649,3	590893,2	97,49	693538,3	118080455,5	975100,78	
250 x 250	250	250	12,00 *	86,77	10805,9	92807158,8	742457,3	95,88	884943,4	152049635,1	1267865,19	2
300 x 300	300	300	10,00	89,04	11170,8	143654801,0	957698,7	117,41	1120327,8	228464140,8	1568713,62	
300 x 300	300	300	12,00 *	105,61	13205,9	166884396,8	1112562,6	116,35	1312443,0	268928112,4	1856756,07	

Metaltub Acesco, cumplen con norma ASTM A500 Grado C. Resistencia a la fluencia mín 345 Mpa (50.000 psi)

* Tubos suministrados en bajo norma ASTM A500 Grado A. Resistencia a la fluencia mín 270 Mpa (39.000 psi)

LARGO DE TUBOS MÁS COMERCIALES

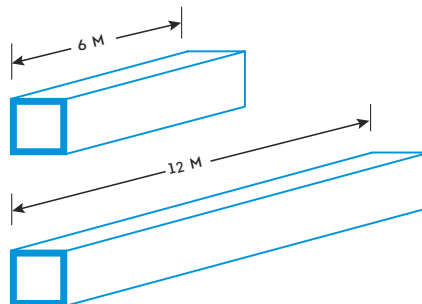

4

4.3 TUBERÍA DE ACERO ESTRUCTURAL RECTANGULAR.

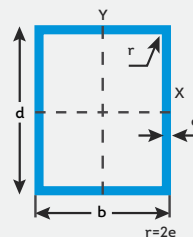

REFERENCIA	REAL		ESPESOR PARED	PESO TEÓRICO CALCULADO	ÁREA A	EJE X-X			EJE Y-Y			MÓDULO PLÁSTICO		MOMENTO DE INERCIA TORCIONAL	CONSTANTE DE CORTE TORCIONAL	UNIDAD DE EMPAQUE
	d [mm]	b [mm]				I _x [mm ⁴]	S _x [mm ³]	r _x [mm]	I _y [mm ⁴]	S _y [mm ³]	r _y [mm]	Z _y [mm ³]	Z _x [mm ³]			
Tubería Rectangular	d [mm]	b [mm]	e [mm]	[kg / m]	[mm ²]	[mm ⁴]	[mm ³]	[mm]	[mm ⁴]	[mm ³]	[mm]	[mm ³]	[mm ³]	J [mm ⁴]	C [mm ³]	
60 x 40	60	40	1,50	13,43	281,3	131434,7	4381,2	22,38	70855,6	3542,8	16,43	4020,2	5287,7	146909,4	6301,74	100
60 x 40	60	40	2,00	17,60	366,8	166953,4	5565,1	22,08	89797,1	4489,9	16,19	5166,4	6799,8	189984,6	8224,09	
76 x 38	76	38	1,50	15,41	323,3	226016,4	5947,8	27,38	78036,5	4107,2	16,09	4577,7	7357,0	187101,4	7608,77	
76 x 38	76	38	2,00	20,24	422,8	288708,9	7597,6	27,05	99256,1	5224,0	15,86	5903,3	9501,4	242174,1	9942,58	72
76 x 38	76	38	2,50	24,91	518,2	345270,3	9086,1	26,71	118216,0	6221,9	15,63	7130,9	11494,0	293766,6	12173,31	
76 x 38	76	38	3,00	29,43	609,4	395817,1	10416,2	26,36	134999,3	7105,2	15,40	8261,7	13336,1	341977,6	14299,81	
90 x 50	90	50	2,00	25,14	526,8	528621,3	11747,1	32,80	215021,2	8600,8	20,92	9657,7	14412,5	491438,4	15759,32	60
90 x 50	90	50	2,50	31,03	648,2	638217,6	14182,6	32,49	258896,4	10355,9	20,69	11753,4	17555,2	600243,7	19388,01	
90 x 50	90	50	3,00	36,78	765,4	739067,5	16423,7	32,16	299026,7	11961,1	20,46	13724,0	20516,2	703673,0	22890,00	
100 x 50	100	50	2,00	27,02	566,8	685336,8	13706,7	36,01	236584,3	9463,4	21,16	10553,1	16961,6	567626,0	17550,13	50
100 x 50	100	50	2,50	33,39	698,2	829276,3	16585,5	35,68	285339,9	11413,6	20,93	12861,8	20695,3	693723,1	21604,90	
100 x 50	100	50	3,00	39,60	825,4	962560,7	19251,2	35,35	330154,4	13206,2	20,70	15041,2	24228,9	813760,8	25524,31	
120 x 60	120	60	2,50	40,45	848,2	1472407,6	24540,1	43,15	508008,2	16933,6	25,35	18916,3	30409,1	1221492,5	31510,56	50
120 x 60	120	60	3,00	48,08	1005,4	1719587,3	28659,8	42,82	591680,8	19722,7	25,12	22225,2	35761,5	1438504,2	37333,27	
150 x 100	150	100	4,00	89,24	1867,3	5424298,0	72324,0	55,81	2922825,2	58456,5	40,97	66517,1	87500,9	6084092,6	104584,90	
150 x 100	150	100	6,00	130,15	2701,5	7519256,4	100256,8	54,58	4037361,7	80747,2	40,00	93986,2	123762,2	8688400,0	151508,15	12
200 x 70	200	70	4,00	96,78	2027,3	8815389,5	88153,9	68,29	1711431,2	48898,0	30,09	54394,0	113787,9	4795804,5	96591,37	
200 x 70	200	70	6,00	141,46	2941,5	12236315,1	122363,2	66,74	2340879,0	66882,3	29,19	76613,8	161285,5	6763260,6	139102,69	
200 x 100	200	100	4,00	108,08	2267,3	10965388,6	109653,9	72,03	3785349,1	75707,0	42,32	84425,2	135692,7	9082015,7	140401,06	6
200 x 100	200	100	6,00	158,41	3301,5	15400971,5	154009,7	70,69	5282471,0	105649,4	41,40	120329,3	193831,4	13020172,2	204194,51	
250 x 100	250	100	5,00	157,11	3292,7	23271620,8	186173,0	87,06	5623177,3	112463,5	42,80	125063,3	236503,0	14939096,6	217176,95	
250 x 150	250	150	5,00	180,66	3792,7	30270316,0	242162,5	92,54	13892040,5	185227,2	62,69	207628,7	293546,8	30272043,2	331264,70	6
300 x 100	300	100	5,00	180,66	3792,7	37112467,2	247416,4	102,46	6680916,3	133618,3	43,47	147232,2	319068,4	18877952,2	261514,70	
300 x 100	300	100	7,00	248,59	5193,7	49360524,2	329070,2	100,93	8787786,2	175755,7	42,59	197602,1	430241,1	25330245,6	356181,97	
300 x 100	300	100	9,00	314,03	6528,3	60166226,1	401108,2	99,34	10596296,9	211925,9	41,69	243224,5	532133,9	31189019,9	445062,16	4
300 x 150	300	150	8,00	319,30	6669,3	70865345,0	472435,6	106,72	24357558,3	324767,4	62,56	367269,1	591174,7	59486600,9	619014,59	
300 x 150	300	150	10,00	392,93	8170,8	84691415,3	564609,4	105,35	28989513,0	386526,8	61,64	443417,7	714801,3	72129191,1	757660,62	
300 x 150	300	150	12,00	464,08	9605,9	97019955,9	646799,7	103,95	33080247,2	441070,0	60,70	513462,3	828924,8	83930368,8	889719,75	2

Metaltub Acesco, cumplen con norma ASTM A500 Grado C. Resistencia a la fluencia mín 345 Mpa (50.000 psi)

* Tubos suministrados en bajo norma ASTM A500 Grado A. Resistencia a la fluencia mín 270 Mpa (39.000 psi)

LARGO DE TUBOS MÁS COMERCIALES

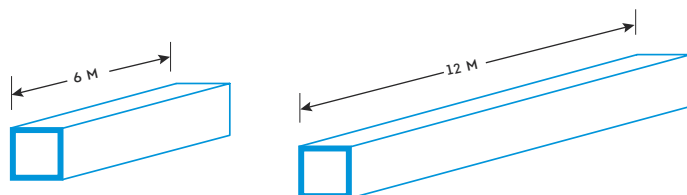

4

4.4 TUBERÍA DE ACERO NEGRO Y GALVANIZADA - CERRAMIENTO.

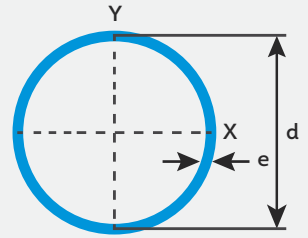

CARACTERÍSTICAS Y DENOMINACIÓN		ESPESOR DE PARED (pulg.)	ESPESOR DE PARED (mm.)	PESO DEL TUBO NEGRO DE 6 MTS (Kg.)	PESO DEL TUBO GALVANIZADO DE 6 M (Kg.)	UNIDAD DE EMPAQUE
DIÁMETRO NOMINAL NPS (pulg.)	DIÁMETRO EXTERIOR (pulg.)					
1/2	0.806	0.047	1.20	3.403	3.595	37
	0.806	0.059	1.50	4.205	4.390	37
	0.815	0.075	1.90	5.295	5.474	37
	0.815	0.090	2.29	6.225	6.396	37
	0.815	0.098	2.49	6.703	6.871	37
3/4	1.017	0.047	1.20	4.349	4.598	37
	1.017	0.059	1.50	5.392	5.635	37
	1.028	0.075	1.90	6.819	7.056	37
	1.028	0.090	2.29	8.054	8.283	37
	1.028	0.098	2.49	8.695	8.919	37
1	1.296	0.105	2.67	9.246	9.467	37
	1.296	0.047	1.20	5.600	5.295	37
	1.296	0.059	1.50	6.963	7.281	37
	1.296	0.075	1.90	8.736	9.046	37
	1.290	0.090	2.29	10.303	10.603	37
1 1/4	1.296	0.098	2.49	11.200	11.497	37
	1.315	0.105	2.67	12.121	12.419	37
	1.315	0.116	2.95	13.269	13.561	37
	1.315	0.128	3.25	14.495	14.781	37
	1.663	0.047	1.20	7.245	7.669	19
1 1/2	1.663	0.059	1.50	9.208	9.445	19
	1.663	0.075	1.90	11.362	11.771	19
	1.638	0.090	2.29	13.291	13.685	19
	1.641	0.098	2.49	14.426	14.816	19
	1.663	0.105	2.67	15.606	15.999	19
2	1.663	0.116	2.95	17.120	17.506	19
	1.663	0.128	3.25	18.744	19.124	19
	1.900	0.047	1.20	8.308	8.796	19
	1.900	0.059	1.50	10.362	10.843	19
	1.900	0.075	1.90	13.058	13.530	19
2 1/2	1.885	0.090	2.29	15.412	15.872	19
	1.883	0.098	2.49	16.688	17.144	19
	1.885	0.105	2.67	17.830	18.282	19
	1.885	0.116	2.95	19.576	20.023	19
	1.885	0.128	3.25	21.455	21.895	19
3	2.360	0.047	1.20	10.371	10.983	19
	2.360	0.059	1.50	12.951	13.557	19
	2.360	0.075	1.90	16.349	16.946	19
	2.360	0.090	2.29	19.490	20.079	19
	2.360	0.098	2.49	21.148	21.732	19
3 1/2	2.360	0.105	2.67	22.588	23.169	19
	2.360	0.116	2.95	24.833	25.408	19
	2.360	0.128	3.25	27.255	27.823	19
	2.850	0.090	2.29	23.697	24.818	7
	2.850	0.098	2.49	25.729	26.446	7
4	2.850	0.105	2.67	27.497	28.209	7
	2.850	0.116	2.95	30.255	30.962	7
	2.850	0.128	3.25	33.239	33.939	7
	3.474	0.090	2.29	29.055	29.944	7
	3.474	0.098	2.49	31.563	32.448	7
4 1/2	3.474	0.105	2.67	33.747	34.629	7
	3.474	0.116	2.95	37.161	38.036	7
	3.474	0.128	3.25	40.859	41.728	7
	4.468	0.090	2.29	37.590	38.747	7
	4.468	0.098	2.49	40.856	42.009	7
5	4.468	0.105	2.67	43.704	44.854	7
	4.468	0.116	2.95	48.161	49.305	7
	4.468	0.128	3.25	52.997	54.134	7

4

4.5 TUBERÍA DE ACERO PARA FABRICACIÓN DE MUEBLES - REDONDOS.

DIMENSIÓN NOMINAL NPS	DIMENSIÓN EXTERIOR		ESPESOR DE PARED			PESO TUBO 6 m (Kg)
	(mm)	(pulg.)	(mm)	(pulg.)	Calibre	
1/2"	12.70	0.500	0.70	0.028	23	1.260
			0.80	0.031	22	1.387
			0.90	0.035	20	1.553
			1.10	0.043	19	1.875
			1.20	0.047	18	2.031
			1.50	0.059	16	2.482
5/8"	15.88	0.625	0.70	0.028	23	1.594
			0.80	0.031	22	1.756
			0.90	0.035	20	1.969
			1.10	0.043	19	2.388
			1.20	0.047	18	2.590
			1.50	0.059	16	3.186
3/4"	19.05	0.750	0.70	0.028	23	1.928
			0.80	0.031	22	2.126
			0.90	0.035	20	2.387
			1.10	0.043	19	2.900
			1.20	0.047	18	3.152
			1.50	0.059	16	3.889
7/8"	22.23	0.875	0.70	0.028	23	2.262
			0.80	0.031	22	2.496
			0.90	0.035	20	2.805
			1.10	0.043	19	3.413
			1.20	0.047	18	3.713
			1.50	0.059	16	4.593
1"	25.40	1.000	1.90	0.075	14	5.724
			0.70	0.028	23	2.596
			0.80	0.031	22	2.866
			0.90	0.035	20	3.222
			1.10	0.043	19	3.926
			1.20	0.047	18	4.273
1 1/8"	28.58	1.125	1.50	0.059	16	5.297
			1.90	0.075	14	6.618
			0.90	0.035	20	3.640
			1.10	0.043	19	4.439
			1.20	0.047	18	4.834
			1.50	0.059	16	6.000
1 1/4"	31.75	1.250	1.90	0.075	14	7.513
			0.80	0.031	22	3.601
			0.90	0.035	20	4.057
			1.10	0.043	19	4.951
			1.20	0.047	18	5.394
			1.50	0.059	16	6.704
1 1/2"	38.10	1.500	1.90	0.075	14	8.407
			0.80	0.031	22	4.344
			0.90	0.035	20	4.892
			1.10	0.043	19	5.977
			1.20	0.047	18	6.515
			1.50	0.059	16	8.111
1.663"	42.24	1.663	1.90	0.075	14	10.196
			0.90	0.035	20	5.436
			1.10	0.043	19	6.646
			1.20	0.047	18	7.246
			1.50	0.059	16	9.028
			1.90	0.075	14	11.362
1.900"	48.26	1.900	0.80	0.031	22	5.528
			0.90	0.035	20	6.227
			1.10	0.043	19	7.618
			1.20	0.047	18	8.308
			1.50	0.059	16	10.362
			1.90	0.075	14	13.058
2.360"	59.94	2.360	1.10	0.043	19	9.504
			1.20	0.047	18	10.371
			1.50	0.059	16	12.951
			1.90	0.075	14	16.349
2.500"	63.50	2.500	1.50	0.059	16	13.739
			1.90	0.075	14	17.351

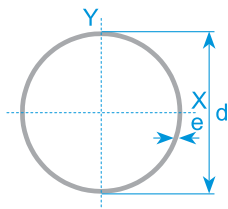

TUBOS REDONDOS

4

4.6 TUBERÍA DE ACERO PARA FABRICACIÓN DE MUEBLES - CUADRADOS, RECTANGULARES Y OVALADOS.

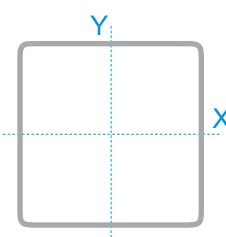

TUBOS CUADRADOS

DIMENSIÓN NOMINAL	DIMENSIÓN EXTERIOR		ESPESOR DE PARED			PESO TUBO 6 m (Kg)
	(mm)	(pulg.)	(mm)	(pulg.)	Calibre	
1/2"	0.50	12.700	0.70	0.028	23	1.594
			0.80	0.031	22	1.757
			0.90	0.035	20	1.970
			1.10	0.043	19	2.388
3/4"	0.75	19.050	0.70	0.028	23	2.450
			0.80	0.031	22	2.703
			0.90	0.035	20	3.039
			1.10	0.043	19	3.700
1"	1.00	25.400	1.20	0.047	18	4.027
			0.70	0.028	23	3.264
			0.80	0.031	22	3.605
			0.90	0.035	20	4.057
1 1/2"	1.50	38.100	1.10	0.043	19	4.951
			1.20	0.047	18	5.394
			1.50	0.059	16	6.704
			0.80	0.031	22	5.527
			0.90	0.035	20	6.227
			1.10	0.043	19	7.618
			1.20	0.047	18	8.308
			1.50	0.059	16	10.362

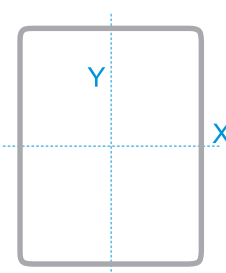

TUBOS RECTANGULARES

DIMENSIÓN EXTERIOR (mm)	ESPESOR DE PARED			PESO TUBO 6 m (Kg)
	(mm)	(pulg.)	Calibre	
12 X 25	0.80	0.031	22	2.496
	0.90	0.035	20	2.804
	1.10	0.043	19	3.413
	1.20	0.047	18	3.713
	1.50	0.059	16	4.593
18 X 32	0.80	0.031	22	3.605
	0.90	0.035	20	4.057
	1.10	0.043	19	4.951
	1.20	0.047	18	5.394
20 X 40	0.80	0.031	22	4.344
	0.90	0.035	20	4.892
	1.10	0.043	19	5.977
	1.20	0.047	18	6.515
25 X 50	1.50	0.059	16	8.111
	0.80	0.031	22	5.527
	0.90	0.035	20	6.227
	1.10	0.043	19	7.618
	1.20	0.047	18	8.308
30 X 44	1.50	0.059	16	10.362
	1.20	0.047	18	8.308
	1.50	0.059	16	10.362
38 X 76	1.00	0.039	19	10.459
	1.10	0.043	19	11.515
	1.20	0.047	18	12.568

4

4.6 TUBERÍA DE ACERO PARA FABRICACIÓN DE MUEBLES - CUADRADOS, RECTANGULARES Y OVALADOS.

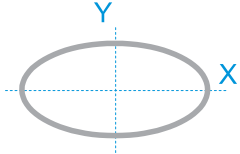

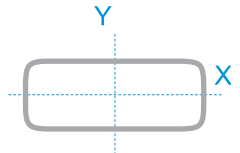

 TUBOS OVALADOS	DIMENSIÓN EXTERIOR (mm)	ESPESOR DE PARED			PESO TUBO 6 m (Kg)
		(mm)	(pulg.)	Calibre	
14 X 28		0.90	0.035	20	2.805
		1.20	0.047	18	3.713
		1.50	0.059	16	4.593
25 X 48		0.90	0.035	20	4.892
		1.10	0.043	19	5.977
		1.20	0.047	18	6.515
		1.50	0.059	16	8.111
31 X 61		0.90	0.035	20	6.228
		1.20	0.047	18	8.309
		1.50	0.059	16	10.362

 TUBOS APLANADOS	DIMENSIÓN EXTERIOR (mm)	ESPESOR DE PARED			PESO TUBO 6 m (Kg)
		(mm)	(pulg.)	Calibre	
10 X 29		0.90	0.035	20	2.805
		1.20	0.047	18	3.713
		1.50	0.059	16	4.593
14 X 29		0.9	0.035	20	3.222
		1.2	0.047	18	4.273
		1.5	0.059	16	5.297
14 X 29		1.1	0.043	19	3.925
		1.50	0.059	16	5.296

4

4.7 RESUMEN

RESUMEN DE TUBOS ESTRUCTURALES MÁS COMERCIALES

DIMENSIÓN (ALTURA)	CONDUCCIÓN			ESTR. CUADRADO			ESTR. REDONDO			ESTR. RECTANGULAR			CERRAMIENTO		
MILIMETROS (PULG.)															
	NOM. PULG.	D.E. MM	ESP. SCH	NOM. PULG.	D.E. MM	ESP. MM	NOM. PULG.	D.E. MM	ESP. MM	NOM. PULG.	D.E. MM	ESP. MM	NOM. PULG.	D.E. MM	ESP. MM
9<h<9.53 (3/8")	3/8"	17.2	40												
	3/8"	17.2	80												
10<h<12.7 (1/2")	1/2"	21.3	40				1/2"	20.5	1.50				1/2"	20.5	1.20
	1/2"	21.3	80				1/2"	20.7	2.00				1/2"	20.5	1.50
13<h<19.05 (3/4")	3/4"	26.7	40				3/4"	25.8	1.50				3/4"	25.8	1.20
	3/4"	26.7	80				3/4"	26.1	2.00				3/4"	25.8	1.50
20<h<25.4 (1")	1"	33.4	40	1"x1"	25 x 25	1.50	1"	32.9	1.50				1"	32.9	1.20
	1"	33.4	80	1"x1"	25 x 25	2.00	1"	32.9	2.00				1"	32.9	1.50
26<h<31.7 (1 1/4")	1 1/4"	42.2	40				1 1/4"	42.2	1.50				1 1/4"	42.2	1.20
	1 1/4"	42.2	80				1 1/4"	42.2	2.00				1 1/4"	42.2	1.50
32<h<38.1 (1 1/2")	1 1/2"	48.2	40	1 1/2"x1 1/2"	40 x 40	1.50	1 1/2"	48.3	1.50				1 1/2"	48.2	1.20
	1 1/2"	48.2	80	1 1/2"x1 1/2"	40 x 40	2.00	1 1/2"	48.3	2.00				1 1/2"	48.2	1.50
39<h<50.8 (2")	2"	60.33	40	2"x2"	50 x 50	1.50	2"	59.9	1.50	2"x1/2"	50 x 13	1.50	2"	59.9	1.20
	2"	60.33	80	2"x2"	50 x 50	2.00	2"	59.9	2.00	2"x11/16"	50 x 30	1.50	2"	59.9	1.50
SUBTOTAL		14						22				4		43	





Los productos sombreados SON de nuestra comercialización habitual.
 Otros productos venta solo bajo pedido, sujeto a entrega del productor.

Nota: Para identificar que productos debían hacer parte del presente resumen, nuestra empresa realizó un análisis basados en su experiencia en el sector. Es posible que en el mercado existan otros elementos de acero de uso estructural que también son comerciales en Colombia pero que no están incluidos en este resumen.

4

4.7 RESUMEN

RESUMEN DE TUBOS ESTRUCTURALES MÁS COMERCIALES

DIMENSION (ALTURA)	CONDUCCIÓN			ESTR. CUADRADO			ESTR. REDONDO			ESTR. RECTANGULAR			CERRAMIENTO								
MILIMETROS (PULG.)																					
	NOM. PULG.	D.E. MM	ESP. SCH	NOM. PULG.	D.E. MM	ESP. MM	NOM. PULG.	D.E. MM	ESP. MM	NOM. PULG.	D.E. MM	ESP. MM	NOM. PULG.	D.E. MM	ESP. MM						
51<h<63.5 (2 1/2")<70	2 1/2"	73	40	23/4"x23/4"	70 x 70	1.50	2 1/2"	72.4	2.00	23/8"x1 1/2"	60 x 40	1.50	2 1/2"	72.3	2.29						
	2 1/2"	73	80	23/4"x23/4"	70 x 70	2.00	2 1/2"	72.4	2.50	23/8"x1 1/2"	60 x 40	2.00	2 1/2"	72.3	2.49						
71<h<76.2 (3")<95	3"	88.9	40	3" x 3"	75 x 75	3.00	3"	88.2	2.00	3" x 1 1/2"	76 x 38	1.50	3"	88.2	2.29						
				3" x 3"	75 x 75	4.00	3"	88.2	2.50	3" x 1 1/2"	76 x 38	2.00	3"	88.2	2.49						
				3" x 3"	75 x 75	5.00	3"	88.2	3.00	3" x 1 1/2"	76 x 38	2.50	3"	88.2	2.67						
				3" x 3"	75 x 75	6.00	3"	88.2	4.00	3" x 1 1/2"	76 x 38	3.00	3"	88.2	2.95						
	3"	88.9	80	3 1/2"x3 1/2"	90 x 90	2.00	3"	88.9	5.50	33/16"x1 1/2"	80 x 40	3.00	3"	88.2	3.25	3.25					
				3 1/2"x3 1/2"	90 x 90	2.50				3 1/2" x 2"	90 x 50	1.50									
				3 1/2"x3 1/2"	90 x 90	3.00				3 1/2" x 2"	90 x 50	2.00									
				3 1/2"x3 1/2"	90 x 90	3.00				3 1/2" x 2"	90 x 50	2.50									
96<h<101.6(4")<125	4"	114.3	40	4" x 4"	100 x 100	3.00	4"	113.5	2.00	4"x1 1/2"	100 x 40	2.00	4"	113.4	2.29						
				4" x 4"	100 x 100	4.00				4"x1 1/2"	100 x 40	2.50				4"	113.4	2.49			
				4" x 4"	100 x 100	5.00				4"x1 1/2"	100 x 40	3.00							4"	113.4	2.67
				4" x 4"	100 x 100	6.00				4"x2"	100 x 50	2.00									
	4"	114.3	80	4" x 4"	100 x 100	6.00	4"	114.3	6.00	4"x2"	100 x 50	2.50	4"	113.4	3.25						
										4"x2"	100 x 50	3.00									
										4"x2"	100 x 50	4.00									
										4"x2"	100 x 50	5.00									
102<H<127 (5")<140	5"	141.3	40	135 x 135	4.00	5"	127	3.40	43/4"x23/8"	120 x 60	2.00	5"	127	3.40							
	5"	141.3	80	135 x 135	5.00				43/4"x23/8"	120 x 60	2.50										
128<h<152.4 (6")	6"	168.3	40	150 x 150	6.00	6"	168.2	3.40	6" x 2"	150 x 50	3.00	6"	168.2	4.00							
									6" x 2"	150 x 50	4.00										
									6" x 2"	150 x 50	5.00										
153<h<203.2 (8")	8"	219.1	40	175 x 175	5.00	8"	219.1	5.00	6" x 4"	150 x 100	6.00	8"	219.1	5.00							
									6" x 4"	150 x 100	6.00										
									6" x 4"	150 x 100	6.00										
									6" x 4"	150 x 100	6.00										
									6" x 4"	150 x 100	6.00										
204<h<254 (10")	10"	273.1	40	220 x 220	7.00	10"	273.1	9.27	200 x 70	4.00	10"	273.1	9.27								
	10"	273.1	80	250 x 250	9.00				200 x 70	4.00											
255<h<304.8 (12")	12"	323.9	40	300 x 300	7.00	12"	323.9	10.30	200 x 70	4.00	12"	323.9	10.30								
305<h<355.6 (14")	14"	377.9	40						200 x 70	4.00											
356<h<406.4 (16")	16"	431.8	40						200 x 70	4.00											
>406.4									200 x 70	4.00											
									200 x 70	4.00											
									200 x 70	4.00											
SUB-TOTAL	17			23			28			38			15								
TOTAL	31			33			50			42			58								
GENERAL							214														

Los productos sombreados SON de nuestra comercialización habitual.
 Otros productos venta solo bajo pedido, sujeto a entrega del productor.

Nota: Para identificar que productos debían hacer parte del presente resumen, nuestra empresa realizó un análisis basados en su experiencia en el sector. Es posible que en el mercado existan otros elementos de acero de uso estructural que también son comerciales en Colombia pero que no están incluidos en este resumen.

The image shows multiple stacks of metal roofing sheets. The sheets have a wavy, corrugated profile and a perforated surface. A large, white, bold number '5' is superimposed over the center of the image. The background is a blurred view of more stacks of these sheets, creating a sense of depth and repetition.

5

**LINEA
ARQUITECTÓNICA**

5

5.0 STEEL DECK 2.0"

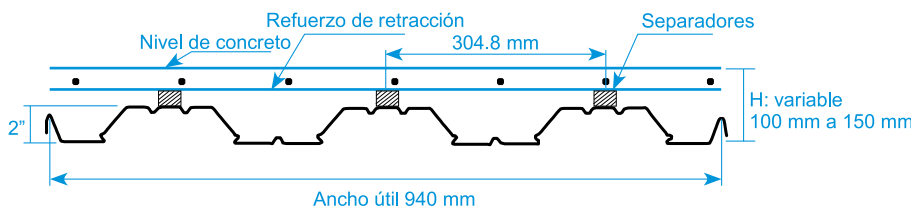

TABLAS DE AYUDA PARA DISEÑO STEEL DECK 2"

Luz (m)	CALIBRE 22 (0.75 mm)			CALIBRE 20 (0.9 mm)			CALIBRE 18 (1.20 mm)			CALIBRE 16 (1.50 mm)		
	100 mm	120 mm	140 mm	100 mm	120 mm	140 mm	100 mm	120 mm	140 mm	100 mm	120 mm	140 mm
2.0	1006	1209	1331	1035	1213	1386	1109	1337	1564	1108	1331	1555
2.1	958	1151	1268	986	1155	1320	1056	1273	1490	1055	1268	1481
2.2	915	1099	1210	941	1103	1260	1008	1215	1422	1007	1210	1414
2.3	875	1051	1157	900	1055	1205	965	1163	1360	963	1158	1352
2.4	838	1008	1109	863	1011	1155	924	1114	1304	923	1110	1296
2.5	805	967	1065	828	970	1109	887	1070	1252	886	1065	1244
2.6	765	930	1024	796	933	1066	853	1028	1203	852	1024	1196
2.7	696	896	986	767	899	1027	822	990	1159	821	986	1152
2.8	634	862	951	739	866	990	792	955	1117	791	951	1111
2.9	579	788	918	707	837	956	765	922	1079	764	918	1072
3.0	529	722	887	649	809	924	740	891	1043	739	888	1037
3.1	-	661	852	-	783	894	-	863	1009	-	859	1003
3.2	-	606	782	-	750	866	-	836	978	-	832	972
3.3	-	557	719	-	691	840	-	810	948	-	807	942
3.4	-	511	661	-	638	815	-	786	920	-	783	915
3.5	-	469	608	-	589	763	-	763	894	-	761	889
3.6	-	431	552	-	544	706	-	682	869	-	740	864
3.7	-	-	493	-	-	653	-	-	846	-	-	841
3.8	-	-	-	-	-	605	-	-	823	-	-	818
3.9	-	-	-	-	-	556	-	-	797	-	-	797
4.0	-	-	-	-	-	501	-	-	744	-	-	778

LUZ MÁXIMA SIN APUNTALAMIENTO (m)

2.01	1.84	1.71	2.30	2.10	1.95	2.81	2.56	2.37	3.25	2.96	2.74
------	------	------	------	------	------	------	------	------	------	------	------

Nota 1: La tabla muestra valores de cargas sobreimpuestas sin mayorar, el peso propio se encuentra incluido en el análisis (no tener en cuenta el peso propio de la losa).

Nota 2: Los valores de esta tabla solo serán válidos si la lámina es debidamente sujeta a la estructura de soporte. Se debe utilizar conectores de cortante para restricción al giro sobre los apoyos.

Nota 3: Para distancias mayores al límite de la luz, la carga sobreimpuesta se calcula bajo la hipótesis de una luz simple con apuntalamiento intermedio.

Nota 4: La tolerancia para el peso del Steel Deck galvanizado es de 5% máximo sobre el recubrimiento y el 1% máximo en el acero base.

Nota 5: Las deflexiones se limitan a un máximo de $L/180$ para la condición de formaleta, y de $L/360$ para el trabajo en sección compuesta, una vez que el concreto ha alcanzado su resistencia máxima.

5

5.0 STEEL DECK 2.0"

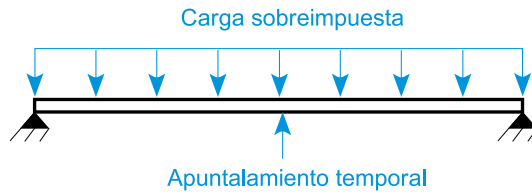

ESPESOR TOTAL DE LA LOSA h (mm) STEEL DECK 2"

100	110	120	130	140	150
-----	-----	-----	-----	-----	-----

LUZ MÁXIMA POR VIBRACIONES (m) STEEL DECK 2"

3.00	3.30	3.60	3.90	4.20	4.50
------	------	------	------	------	------

CONSUMO DE CONCRETO TEÓRICO (m³/m²) STEEL DECK 2"

0.072	0.082	0.092	0.102	0.112	0.122
-------	-------	-------	-------	-------	-------

PESO LÁMINA STEEL DECK 2"

	22 (0.75 mm)	20 (0.90 mm)	18 (1.20 mm)	16 (1.50 mm)
Kgf/m	7.12	8.55	11.33	14.20
KGf/m ²	7.57	9.10	12.05	15.11

5

5.1 STEEL DECK 3.0"

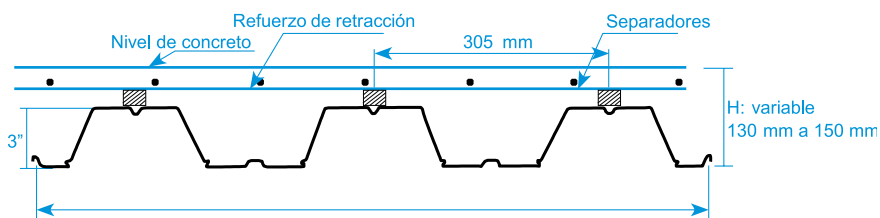

TABLAS DE AYUDA PARA DISEÑO STEEL DECK 3"

Luz (m)	CALIBRE 22 (0.75 mm)		CALIBRE 20 (0.9 mm)		CALIBRE 18 (1.20 mm)		CALIBRE 16 (1.50 mm)	
	130 mm	150 mm	130 mm	150 mm	130 mm	150 mm	130 mm	150 mm
	ESPESOR TOTAL DE LA LOSA							
2.0	1842	1950	1950	1950	1950	1950	1950	1950
2.1	1650	1950	1950	1950	1950	1950	1950	1950
2.2	1483	1879	1778	1950	1950	1950	1950	1950
2.3	1338	1695	1607	1950	1907	1950	1905	1950
2.4	1210	1535	1458	1849	1828	1950	1826	1950
2.5	1097	1393	1325	1683	1754	1898	1753	1894
2.6	998	1267	1208	1535	1610	1825	1685	1821
2.7	909	1155	1104	1403	1476	1758	1623	1753
2.8	829	1055	1010	1285	1356	1695	1565	1691
2.9	757	965	926	1180	1249	1590	1511	1632
3.0	693	883	851	1084	1152	1467	1436	1578
3.1	635	810	782	998	1064	1356	1330	1527
3.2	582	743	720	919	984	1256	1233	1479
3.3	533	683	664	848	912	1164	1146	1435
3.4	489	627	612	783	845	1080	1066	1361
3.5	449	576	565	723	785	1004	993	1269
3.6	412	530	521	669	729	934	925	1184
3.7	378	487	481	618	678	869	844	1106
3.8	347	447	444	572	631	809	762	1034
3.9	318	411	410	529	587	754	687	967
4.0	-	377	-	489	-	703	-	905

LUZ MÁXIMA SIN APUNTALAMIENTO (m)

2.42	2..24	2.81	2.59	3.49	3.22	3.96	3.65
------	-------	------	------	------	------	------	------

Nota 1: La tabla muestra valores de cargas sobreimpuestas sin mayorar, el peso propio se encuentra incluido en el análisis (no tener en cuenta el peso propio de la losa).

Nota 2: Los valores de esta tabla solo serán válidos si la lámina es debidamente sujeta a la estructura de soporte. Se debe utilizar conectores de cortante para restricción al giro sobre los apoyos.

Nota 3: Para distancias mayores al límite de la luz, la carga sobreimpuesta se calcula bajo la hipótesis de una luz simple con apuntalamiento intermedio.

Nota 4: La tolerancia para el peso del Steel Deck galvanizado es de 5% máximo sobre el recubrimiento y el 1% máximo en el acero base.

Nota 5: Las deflexiones se limitan a un máximo de $L/180$ para la condición de formaleta, y de $L/360$ para el trabajo en sección compuesta, una vez que el concreto ha alcanzado su resistencia máxima.

5

5.1 STEEL DECK 3.0"

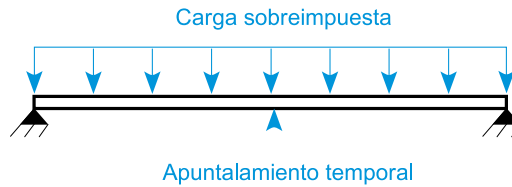

ESPESOR TOTAL DE LA LOSA h (mm) STEEL DECK 3"

130	140	150
-----	-----	-----

LUZ MÁXIMA POR VIBRACIONES (m) STEEL DECK 3"

3.90	4.20	4.50
------	------	------

CONSUMO DE CONCRETO TEÓRICO (m³/m²) STEEL DECK 3"

0.091	0.101	0.111
-------	-------	-------

PESO LÁMINA STEEL DECK 3"

	22 (0.75 mm)	20 (0.90 mm)	18 (1.20 mm)	16 (1.50 mm)
Kgf/m	7.12	8.55	11.33	14.20
Kgf/m ²	8.18	9.83	13.02	16.32

5

5.2 PERFIL EN C NEGRO

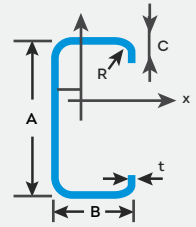

PROPIEDADES MECÁNICAS DE LA SECCIÓN COMPLETA - PERFIL ESTRUCTURAL C NEGRO

REFERENCIA PERFIL	ESPESOR (mm)	CALIBRE #	A (mm)	B (mm)	C (mm)	PESO (kg/m)	ÁREA (mm ²)	X CENT (mm)	X _o CORTE (mm)	ST VE- NANTJ (mm ²)	WARPING C _w (mm ²)	J TORS (mm ⁴)	MOMENTO DE INERCIA		MÓDULO DE SECCIÓN		RADIO DE GIRO		
													I _x (mm ⁴)	I _y (mm ⁴)	S _x (mm ³)	S _y (mm ³)	r _x (mm)	r _y (mm)	r _o (mm)
100 X 50 - 3.0 mm	3.0	11	100	50	15	5.06	620.52	17.047	-38.787	1861.60	411359072	58.615	958213	198665	19056	6029	39.185	17.893	57.966
100 X 50 - 2.5 mm	2.5	12	100	50	15	4.22	523.17	17.056	-39.400	1089.90	362593760	59.100	813385	171906	16268	5218	39.430	18.127	58.614
100 X 50 - 2.0 mm	2.0	14	100	50	15	3.38	423.40	17.064	-40.011	564.53	306571456	59.585	666448	142748	13329	4334	39.674	18.362	59.263
100 X 50 - 1.5 mm	1.5	16	100	50	15	2.53	321.19	17.073	-40.621	240.89	242810944	60.069	511822	111085	10236	3374	39.919	18.597	59.912
100 X 50 - 1.2 mm	1.2	18	100	50	15	2.03	258.70	17.077	-40.986	124.18	200633216	60.360	415282	90841	8306	2759	40.066	18.739	60.301
120 X 60 - 3.0 mm	3.0	11	120	60	15	6.12	740.52	19.609	-45.129	2221.60	946705E+08	70.769	1671544	335164	27859	8298	47.511	21.275	68.894
120 X 60 - 2.5 mm	2.5	12	120	60	15	5.10	623.17	19.620	-45.742	1298.30	827091008	71.241	1421339	288454	23689	7143	47.758	21.515	69.542
120 X 60 - 2.0 mm	2.0	14	120	60	15	4.08	503.40	19.630	-46.354	671.20	693275264	71.713	1160070	238253	19334	5902	48.005	21.755	70.189
120 X 60 - 1.5 mm	1.5	16	120	60	15	3.06	381.19	19.641	-46.965	285.90	544478592	72.186	887521	184436	14792	4570	48.252	21.996	70.837
120 X 60 - 1.2 mm	1.2	18	120	60	15	2.45	306.70	19.647	-47.331	147.22	447675296	72.469	718487	150357	11975	3726	48.401	22.141	71.226
150 X 50 - 3.0 mm	3.0	11	150	50	17	6.31	782.52	14.549	-34.450	2347.60	1.07760E+09	78.430	2536912	242032	33825	6827	56.938	17.587	68.834
150 X 50 - 2.5 mm	2.5	12	150	50	17	5.26	658.17	14.535	-35.022	1371.20	942218432	78.658	2154637	209069	28728	5895	57.216	17.823	69.411
150 X 50 - 2.0 mm	2.0	14	150	50	17	4.21	531.40	14.522	-35.594	708.50	790381824	78.889	1756495	173314	23420	4885	57.493	18.060	69.989
150 X 50 - 1.5 mm	1.5	16	150	50	17	3.16	402.19	14.509	-36.165	301.60	621178368	79.123	1342224	134651	17896	3794	57.769	18.297	70.569
150 X 50 - 1.2 mm	1.2	18	150	50	17	2.52	323.50	14.501	-36.507	155.30	510940352	79.265	1085811	110007	14477	3099	57.935	18.440	70.917
160 X 60 - 3.0 mm	3.0	11	160	60	20	7.16	890.52	18.479	-43.970	2671.60	2.19110E+09	84.968	3400208	418866	42503	10088	61.792	21.688	78.879
160 X 60 - 2.5 mm	2.5	12	160	60	20	5.97	748.17	18.472	-44.551	1558.70	1.90170E+09	85.299	2881149	359557	36014	8658	62.056	21.922	79.475
160 X 60 - 2.0 mm	2.0	14	160	60	20	4.77	603.40	18.465	-45.131	804.50	1.58380E+09	85.631	2343414	296234	29293	7132	62.319	22.157	80.071
160 X 60 - 1.5 mm	1.5	16	160	60	20	3.58	456.19	18.459	-45.711	342.10	1.23610E+09	85.965	1786715	228757	22334	5507	62.583	22.393	80.669
160 X 60 - 1.2 mm	1.2	18	160	60	20	2.86	366.70	18.455	-46.058	176.00	1.01260E+09	86.166	1443477	186220	18043	4482	62.740	22.535	81.028
220 X 80 - 3.0 mm	3.0	11	220	80	20	9.56	1190.50	22.540	-54.720	3571.60	8.72360E+09	118.590	8690372	943603	79003	16421	85.440	28.150	105.290
220 X 80 - 2.5 mm	2.5	12	220	80	20	7.97	998.17	22.530	-55.300	2079.50	7.49840E+09	118.850	7333024	804923	66664	14006	85.710	28.400	105.880
220 X 80 - 2.0 mm	2.0	14	220	80	20	6.37	803.40	22.520	-55.880	1071.20	6.18580E+09	119.120	5939783	659059	53998	11467	85.980	28.640	106.470
220 X 80 - 1.5 mm	1.5	16	220	80	20	4.78	606.19	22.520	-56.450	454.60	4.78280E+09	119.390	4510252	505823	41002	8800	86.260	28.890	107.060
220 X 80 - 1.2 mm	1.2	18	220	80	20	3.82	486.70	22.510	-56.800	233.60	3.89630E+09	119.550	3634953	410265	33045	7137	86.420	29.030	107.410
305 X 80 - 3.0 mm	3.0	11	305	80	25	11.73	1475.50	20.040	-50.510	4427.00	2.06740E+10	166.070	19389458	1141419	127144	19036	114.630	27.810	128.320
305 X 80 - 2.5 mm	2.5	12	305	80	25	9.77	1235.70	20.010	-51.050	2574.00	1.77050E+10	165.990	16323594	972436	107040	16210	114.940	28.050	128.850
305 X 80 - 2.0 mm	2.0	14	305	80	25	7.82	993.40	19.980	-51.590	1324.50	1.45530E+10	165.910	13192153	795229	86506	13249	115.240	28.290	129.390
305 X 80 - 1.5 mm	1.5	16	305	80	25	5.86	748.69	19.950	-52.130	561.50	1.12120E+10	165.840	9994609	609596	65538	10151	115.540	28.530	129.930
355 X 110 - 3.0 mm	3.0	11	355	110	25	14.25	1805.50	27.890	-70.210	5417.00	6.20550E+10	192.380	33554588	2613640	189040	31830	136.320	38.050	157.990
355 X 110 - 2.5 mm	2.5	12	355	110	25	11.87	1510.70	27.870	-70.770	3147.00	5.28310E+10	192.470	28195212	2215429	158846	26975	136.620	38.300	158.550
355 X 110 - 2.0 mm	2.0	14	355	110	25	9.50	1213.40	27.850	-71.330	1618.00	4.31720E+10	192.560	22743454	1802626	128132	21944	136.910	38.540	159.110

5

5.3 PERFIL EN C GALVANIZADO

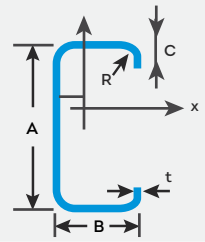

PROPIEDADES MECÁNICAS DE LA SECCIÓN COMPLETA - PERFIL ESTRUCTURAL C GALVANIZADO

REFERENCIA PERFIL	ESPESOR (mm)	CALIBRE #	A (mm)	B (mm)	C (mm)	PESO (kgf/m)	ÁREA (mm ²)	X CENT (mm)	Xo CORTE (mm)	ST VE-NANT J (mm ²)	WARPING Cw (mm ²)	J TORS (mm)	MOMENTO DE INERCIA		MÓDULO DE SECCIÓN		RADIO DE GIRO		
													Ix (mm ⁴)	Iy (mm ⁴)	Sx (mm ³)	Sy (mm ³)	rx (mm)	ry (mm)	ro (mm)
100 X 50 - 1.9 mm	1.9	14	100	50	15	3.19	397.06	17.066	-40.17	462.82	290758176	59.711	626992	134760	12540	4092	39.738	18.423	59.432
100 X 50 - 1.5 mm	1.5	16	100	50	15	2.50	312.91	17.073	-40.67	222.33	237361520	60.108	499115	108440	9982.3	3293.4	39.938	18.616	59.964
100 X 50 - 1.2 mm	1.2	18	100	50	15	2.00	250.31	17.078	-41.035	112.27	194779648	60.399	402194	88070	8043.9	2675.1	40.085	18.758	60.353
120 X 60 - 1.9 mm	1.9	14	120	60	15	3.86	471.86	19.633	-46.513	550	656061632	71.836	1090301	224614	18172	5564	48.069	21.818	70.357
120 X 60 - 1.5 mm	1.5	16	120	60	15	3.03	371.31	19.642	-47.014	263.8	531903904	72.224	865224	179970	14420	4459	48.272	22.016	70.889
120 X 60 - 1.2 mm	1.2	18	120	60	15	2.41	296.71	19.648	-47.38	133.08	434328480	72.507	695634	145709	11594	3611	48.42	22.161	71.277
150 X 50 - 1.9 mm	1.9	14	150	50	17	3.98	498.04	14.519	-35.742	580.5	748094912	78.95	1650346	163546	22005	4609	57.565	18.121	70.14
150 X 50 - 1.5 mm	1.5	16	150	50	17	3.12	391.75	14.508	-36.211	278.4	606866112	79.142	1308378	131428	17445	3703	57.791	18.316	70.615
150 X 50 - 1.2 mm	1.2	18	150	50	17	2.49	312.95	14.5	-36.553	140.37	495733280	79.285	1051174	106637	14016	3004	57.957	18.459	70.964
160 X 60 - 1.9 mm	1.9	14	160	60	20	4.52	565.36	18.464	-45.282	659	1.49630E+09	85.718	2200507	279095	27506	6719	62.388	22.218	80.227
160 X 60 - 1.5 mm	1.5	16	160	60	20	3.54	444.31	18.458	-45.757	315.7	1.20690E+09	85.992	1741352	223176	21767	5372	62.604	22.412	80.717
160 X 60 - 1.2 mm	1.2	18	160	60	20	2.82	354.70	18.454	-46.105	159.1	981878976	86.193	1397185	180430	17465	4343	62.761	22.554	81.076
220 X 80 - 1.9 mm	1.9	14	220	80	20	6.03	752.36	22.52	-56.03	877	5.82980E+09	119.19	5571611	619934	50651	10786	86.06	28.71	106.62
220 X 80 - 1.5 mm	1.5	16	220	80	20	4.73	590.31	22.52	-56.5	419.4	4.66650E+09	119.41	4394310	493240	39948	8581	86.28	28.91	107.11
220 X 80 - 1.2 mm	1.2	18	220	80	20	3.77	470.70	22.51	-56.85	211.1	3.77550E+09	119.58	3517244	397316	31975	6911	86.44	29.05	107.46
305 X 80 - 1.9 mm	1.9	14	305	80	25	7.40	930.01	19.97	-51.73	1084	1.37020E+10	165.89	12367179	747785	81096	12457	115.32	28.36	129.53
305 X 80 - 1.5 mm	1.5	16	305	80	25	5.80	729.01	19.95	-52.17	518	1.09360E+10	165.83	9735936	594375	63842	9897	115.56	28.55	129.97
355 X 110 - 1.9 mm	1.9	14	355	110	25	8.99	1135.70	27.85	-71.47	1324	4.05890E+10	192.58	21310786	1692872	120061	20607	136.98	38.61	159.26

5

5.4 PERFIL EN Z NEGRO Y GALVANIZADO

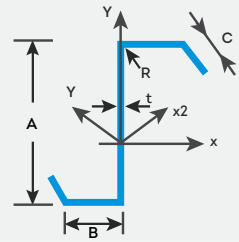

PROPIEDADES MECÁNICAS DE LA SECCIÓN COMPLETA - PERFIL ESTRUCTURAL Z NEGRO

REFERENCIA PERFIL	ESPESOR (mm)	CALIBRE #	A (mm)	B (mm)	C (mm)	PESO (kgf/m)	ÁREA (mm ²)	X CENT (mm)	Xo CORTE (mm)	ST VENANT J (mm ⁴)	WARPING Cw (mm ⁶)	J TORS (mm)	MOMENTO DE INERCIA		MÓDULO DE SECCIÓN		RADIO DE GIRO		
													Ix (mm ⁴)	Iy (mm ⁴)	Sx (mm ³)	Sy (mm ³)	rx (mm)	ry (mm)	ro (mm)
160 X 60 - 3.0 mm	3.0	11	160	60	20	7.16	910.68	68.50	80.0	2732.00	4.49530E+09	60.0	3535379	817170	44192	11929	62.307	29.955	69.134
160 X 60 - 2.5 mm	2.5	12	160	60	20	5.97	763.51	68.75	80.0	1590.60	2.99680E+09	60.0	2986915	695757	37336	10120	62.547	30.187	69.450
160 X 60 - 2.0 mm	2.0	14	160	60	20	4.77	614.50	69.00	80.0	819.30	2.46610E+09	60.0	2422463	568624	30281	8241	62.787	30.419	69.768
160 X 60 - 1.5 mm	1.5	16	160	60	20	3.58	463.64	69.25	80.0	347.70	1.90210E+09	60.0	1841786	435630	23022	6291	63.027	30.653	70.086
160 X 60 - 1.2 mm	1.2	18	160	60	20	2.86	372.24	69.40	80.0	178.70	1.54740E+09	60.0	1485492	352959	18569	5086	63.172	30.793	70.277
220 X 80 - 3.0 mm	3.0	11	220	80	20	9.56	1210.70	88.50	110.0	3632.00	1.36780E+10	60.0	8943624	1691311	81306	19111	85.949	37.376	93.724
220 X 80 - 2.5 mm	2.5	12	220	80	20	7.97	1013.50	88.75	110.0	2111.00	1.16500E+10	60.0	7529888	1433572	68454	16153	86.195	37.610	94.043
220 X 80 - 2.0 mm	2.0	14	220	80	20	6.37	814.50	89.00	110.00	1086.00	9.52460E+09	60.0	6085846	1166428	55326	13106	86.440	37.843	94.361
220 X 80 - 1.5 mm	1.5	16	220	80	20	4.78	613.64	89.25	110.0	460.20	7.29930E+09	60.0	4611166	889685	41920	9968	86.686	38.077	94.680
220 X 80 - 1.2 mm	1.2	18	220	80	20	3.82	492.24	89.40	110.0	236.30	5.91520E+09	60.0	3711514	718958	33741	8042	86.833	38.218	94.872
305 X 80 - 3.0 mm	3.0	11	305	80	25	11.73	1495.70	91.00	152.5	4487.00	3.26290E+10	60.0	19889894	1926243	130426	21168	115.317	35.887	120.772
305 X 80 - 2.5 mm	2.5	12	305	80	25	9.77	1251.00	91.25	152.5	2606.00	2.77230E+10	60.0	16712433	1631367	109590	17878	115.582	36.112	121.092
305 X 80 - 2.0 mm	2.0	14	305	80	25	7.82	1004.50	91.50	152.5	1339.00	2.26110E+10	60.0	13480558	1326289	88397	14495	115.845	36.337	121.411
305 X 80 - 1.5 mm	1.5	16	305	80	25	5.86	756.14	91.75	152.5	567.00	1.72870E+10	60.0	10193818	1010816	66845	11017	116.109	36.562	121.730

PROPIEDADES MECÁNICAS DE LA SECCIÓN COMPLETA - PERFIL ESTRUCTURAL Z GALVANIZADO

REFERENCIA PERFIL	ESPESOR (mm)	CALIBRE #	A (mm)	B (mm)	C (mm)	PESO (kgf/m)	ÁREA (mm ²)	X CENT (mm)	Xo CORTE (mm)	ST VENANT J (mm ⁴)	WARPING Cw (mm ⁶)	J TORS (mm)	MOMENTO DE INERCIA		MÓDULO DE SECCIÓN		RADIO DE GIRO		
													Ix (mm ⁴)	Iy (mm ⁴)	Sx (mm ³)	Sy (mm ³)	rx (mm)	ry (mm)	ro (mm)
160 X 60 - 1.9 mm	1.9	14	160	60	20	4.52	575.46	69.07	80.0	670.80	2.32270E+09	60.0	2273057	534615	28413	7741	62.849	30.480	69.850
160 X 60 - 1.5 mm	1.5	16	160	60	20	3.54	451.50	69.27	80.0	320.80	1.85550E+09	60.0	1794623	424733	22433	6132	63.046	30.671	70.111
160 X 60 - 1.2 mm	1.2	18	160	60	20	2.82	360.01	69.42	80.0	161.50	1.49910E+09	60.0	1437536	341770	17969	4923	63.191	30.811	70.302
220 X 80 - 1.9 mm	1.9	14	220	80	20	6.03	762.46	89.06	110.0	889.00	8.95570E+09	60.0	5705390	1095405	51867	12300	86.504	37.903	94.443
220 X 80 - 1.5 mm	1.5	16	220	80	20	4.73	597.50	89.27	110.0	424.50	7.11690E+09	60.0	4491858	867127	40835	9714	86.705	38.095	94.705
220 X 80 - 1.2 mm	1.2	18	220	80	20	3.77	476.01	89.42	110.0	213.50	5.72780E+09	60.0	3590715	695927	32643	7783	86.653	38.236	94.897
305 X 80 - 1.9 mm	1.9	14	305	80	25	7.40	940.11	91.56	152.5	1096.00	2.12470E+10	60.0	12631301	1245275	82828	13601	115.914	36.395	121.493
305 X 80 - 1.5 mm	1.5	16	305	80	25	5.80	736.20	91.77	152.5	523.00	1.68520E+10	60.0	9928500	985124	65105	10735	116.130	36.580	121.755

5

5.5 PERFIL ESTRUCTURAL C CAJÓN NEGRO

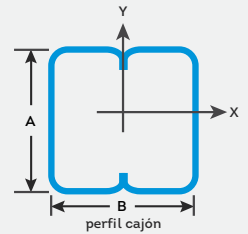

PROPIEDADES MECÁNICAS DE LA SECCIÓN COMPLETA - PERFIL ESTRUCTURAL C CAJÓN NEGRO

REFERENCIA PERFIL	ESPESOR (mm)	CALIBRE #	A (mm)	B (mm)	C (mm)	PESO (kg/m)	ÁREA (mm ²)	X CENT (mm)	Y CENT (mm)	MOMENTO DE INERCIA		MÓDULO DE SECCIÓN		RADIO DE GIRO		
										I _x (mm ⁴)	I _y (mm ⁴)	S _x (mm ³)	S _y (mm ³)	r _x (mm)	r _y (mm)	r _o (mm)
100 X 50 - 3.0 mm	3.0	11	100	50	15	10.13	1241.00	50.0	50.0	1905627	1744.979	38.113	34900	39.186	37.498	54.237
100 X 50 - 2.5 mm	2.5	12	100	50	15	8.44	1046.30	50.0	50.0	1626770	1479443	32535	29589	39.431	37.603	54.486
100 X 50 - 2.0 mm	2.0	14	100	50	15	6.75	846.80	50.0	50.0	1332895	1204072	26658	24081	39.674	37.708	54.735
100 X 50 - 1.5 mm	1.5	16	100	50	15	5.06	642.38	50.0	50.0	1023644	918656	20473	18373	39.919	37.816	54.987
100 X 50 - 1.2 mm	1.2	18	100	50	15	4.05	517.41	50.0	50.0	830564	742497	16611	14850	40.065	37.882	55.139
120 X 60 - 3.0 mm	3.0	11	120	60	15	12.25	1481.00	60.0	60.0	3343088	3086590	55718	51443	47.511	45.652	65.890
120 X 60 - 2.5 mm	2.5	12	120	60	15	10.21	1246.30	60.0	60.0	2842677	2609168	47378	43486	47.759	45.755	66.139
120 X 60 - 2.0 mm	2.0	14	120	60	15	8.16	1006.80	60.0	60.0	2320140	2117281	38669	35288	48.005	45.858	66.389
120 X 60 - 1.5 mm	1.5	16	120	60	15	6.12	762.38	60.0	60.0	1775043	1610678	29584	26845	48.252	45.964	66.641
120 X 60 - 1.2 mm	1.2	18	120	60	15	4.90	613.41	60.0	60.0	1436975	1299546	23950	21659	48.400	46.028	66.792
150 X 50 - 3.0 mm	3.0	11	150	50	17	12.62	1565.00	50.0	75.0	5073825	2450951	67651	49019	56.939	39.574	69.341
150 X 50 - 2.5 mm	2.5	12	150	50	17	10.52	1316.30	50.0	75.0	4309274	2073756	57457	41475	57.217	39.692	69.636
150 X 50 - 2.0 mm	2.0	14	150	50	17	8.42	1062.80	50.0	75.0	3512990	1684360	46840	33687	57.493	39.810	69.930
150 X 50 - 1.5 mm	1.5	16	150	50	17	6.31	804.38	50.0	75.0	2684448	1282528	35793	25651	57.769	39.930	70.226
150 X 50 - 1.2 mm	1.2	18	150	50	17	5.05	647.01	50.0	75.0	2171621	1035360	28955	20707	57.934	40.003	70.403
160 X 60 - 3.0 mm	3.0	11	160	60	20	14.32	1781.00	60.0	80.0	6800416	3908291	85005	65138	61.793	46.845	77.542
160 X 60 - 2.5 mm	2.5	12	160	60	20	11.93	1496.30	60.0	80.0	5762299	3299688	72029	54995	62.057	46.960	77.822
160 X 60 - 2.0 mm	2.0	14	160	60	20	9.55	1206.80	60.0	80.0	4686828	2674347	58585	44572	62.319	47.075	78.101
160 X 60 - 1.5 mm	1.5	16	160	60	20	7.16	912.38	60.0	80.0	3573431	2031990	44668	33867	62.583	47.192	78.382
160 X 60 - 1.2 mm	1.2	18	160	60	20	5.73	733.41	60.0	80.0	2886954	1638292	36087	27305	62.740	47.263	78.550
220 X 80 - 3.0 mm	3.0	11	220	80	20	19.12	2381.00	80.0	110.0	17380746	9749384	158007	121867	85.439	63.990	106.745
220 X 80 - 2.5 mm	2.5	12	220	80	20	15.94	1996.30	80.0	110.0	14666047	8203249	133328	102541	85.712	64.103	107.032
220 X 80 - 2.0 mm	2.0	14	220	80	20	12.75	1606.80	80.0	110.0	11879564	6626110	107996	82826	85.984	64.217	107.318
220 X 80 - 1.5 mm	1.5	16	220	80	20	9.56	1212.40	80.0	110.0	9020504	5017594	82005	62720	86.257	64.332	107.605
220 X 80 - 1.2 mm	1.2	18	220	80	20	7.65	973.41	80.0	110.0	7269906	4037266	66090	50466	86.420	64.401	107.778
305 X 80 - 3.0 mm	3.0	11	305	80	25	23.46	2951.00	80.0	152.5	38778916	12892696	254288	161159	114.634	66.098	132.325
305 X 80 - 2.5 mm	2.5	12	305	80	25	19.55	2471.30	80.0	152.5	32647188	10839242	214080	135491	114.937	66.227	132.652
305 X 80 - 2.0 mm	2.0	14	305	80	25	15.64	1986.80	80.0	152.5	26384306	8748217	173012	109353	115.238	66.356	132.977
305 X 80 - 1.5 mm	1.5	16	305	80	25	11.73	1497.40	80.0	152.5	19989218	6619208	131077	82740	115.539	66.487	133.303
355 X 110 - 3.0 mm	3.0	11	355	110	25	28.50	3611.00	110.0	177.5	67109176	29574700	378080	268861	136.326	90.500	163.630
355 X 110 - 2.5 mm	2.5	12	355	110	25	23.75	3021.30	110.0	177.5	56390424	24810804	317693	225553	136.617	90.620	163.940
355 X 110 - 2.0 mm	2.0	14	355	110	25	19.00	2426.80	110.0	177.5	45486912	19981550	256264	181650	136.907	90.740	164.248

5

5.6 PERFIL ESTRUCTURAL C CAJÓN GALVANIZADO

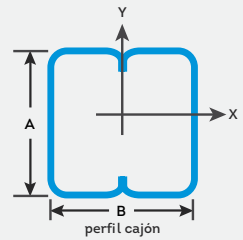

PROPIEDADES MECÁNICAS DE LA SECCIÓN COMPLETA - PERFIL ESTRUCTURAL C CAJÓN GALVANIZADO

REFERENCIA PERFIL	ESPESOR (mm)	CALIBRE #	A (mm)	B (mm)	C (mm)	PESO (kgf/m)	ÁREA (mm ²)	X CENT (mm)	Y CENT (mm)	MOMENTO DE INERCIÁ		MÓDULO DE SECCIÓN		RADIO DE GIRO		
										I _x (mm ⁴)	I _y (mm ⁴)	S _x (mm ³)	S _y (mm ³)	r _x (mm)	r _y (mm)	r _o (mm)
100 X 50 - 1.9 mm	1.9	14	100	50	15	6.39	794.12	50.0	50.0	1253984	1130838	25080	22617	39.738	37.736	54.801
100 X 50 - 1.5 mm	1.5	16	100	50	15	5.01	625.82	50.0	50.0	998230	895383	19965	17908	39.938	37.825	55.007
100 X 50 - 1.2 mm	1.2	18	100	50	15	3.99	500.61	50.0	50.0	804387	718728	16088	14375	40.085	37.891	55.159
120 X 60 - 1.9 mm	1.9	14	120	60	15	7.73	943.72	60.0	60.0	2180602	1986990	36343	33117	48.069	45.886	66.454
120 X 60 - 1.5 mm	1.5	16	120	60	15	6.05	742.62	60.0	60.0	1730448	1569507	28841	26158	48.272	45.973	66.661
120 X 60 - 1.2 mm	1.2	18	120	60	15	4.83	593.41	60.0	60.0	1391269	1257652	23188	20961	48.420	46.037	66.812
150 X 50 - 1.9 mm	1.9	14	150	50	17	7.96	996.08	50.0	75.0	3300693	1581090	44009	31622	57.565	39.841	70.007
150 X 50 - 1.5 mm	1.5	16	150	50	17	6.24	783.50	50.0	75.0	2616756	1249837	34890	24997	57.791	39.940	70.250
150 X 50 - 1.2 mm	1.2	18	150	50	17	4.98	625.89	50.0	75.0	2102347	1002056	28031	20041	57.957	40.013	70.427
160 X 60 - 1.9 mm	1.9	14	160	60	20	9.03	1130.70	60.0	80.0	4401014	2508983	55013	41816	62.388	47.106	78.175
160 X 60 - 1.5 mm	1.5	16	160	60	20	7.08	888.62	60.0	80.0	3482703	1979858	43534	32998	62.604	47.202	78.404
160 X 60 - 1.2 mm	1.2	18	160	60	20	5.65	709.41	60.0	80.0	2794370	1585325	34930	26422	62.761	47.273	78.573
220 X 80 - 1.9 mm	1.9	14	220	80	20	12.07	1504.70	80.0	110.0	11143222	6210931	101302	77637	86.056	64.247	107.393
220 X 80 - 1.5 mm	1.5	16	220	80	20	9.45	1180.60	80.0	110.0	8788620	4887546	79897	61094	86.280	64.342	107.629
220 X 80 - 1.2 mm	1.2	18	220	80	20	7.54	941.41	80.0	110.0	7034488	3905689	63950	48821	86.442	64.411	107.801
305 X 80 - 1.9 mm	1.9	14	305	80	25	14.80	1860.00	80.0	152.5	24734358	8198349	162193	102479	115.317	66.391	133.063
305 X 80 - 1.5 mm	1.5	16	305	80	25	11.59	1458.00	80.0	152.5	19471872	6447235	127684	80590	115.565	66.498	133.331
355 X 110 - 1.9 mm	1.9	14	355	110	25	17.98	2271.40	110.0	177.5	42621584	18715170	240122	170138	136.983	90.772	164.329

5

5.7 PERFIL ESTRUCTURAL I NEGRO

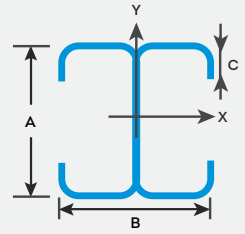

PROPIEDADES MECÁNICAS DE LA SECCIÓN COMPLETA - PERFIL ESTRUCTURAL I NEGRO																
REFERENCIA PERFIL	ESPESOR (mm)	CALIBRE #	A (mm)	B (mm)	C (mm)	PESO (kgf/m)	ÁREA (mm ²)	X CENT (mm)	Y CENT (mm)	MOMENTO DE INERCIA		MÓDULO DE SECCIÓN		RADIO DE GIRO		
										I _x (mm ⁴)	I _y (mm ⁴)	S _x (mm ³)	S _y (mm ³)	r _x (mm)	r _y (mm)	r _o (mm)
100 X 50 - 3.0 mm	3.0	11	100	50	15	10.13	1241.00	50.0	50.0	1905627	757979	38.113	15160	39.186	24.714	46.329
100 X 50 - 2.5 mm	2.5	12	100	50	15	8.44	1046.30	50.0	50.0	1626770	648193	32535	12964	39.431	24.890	46.629
100 X 50 - 2.0 mm	2.0	14	100	50	15	6.75	846.80	50.0	50.0	1332895	532072	26658	10641	39.674	25-067	46.929
100 X 50 - 1.5 mm	1.5	16	100	50	15	5.06	642.38	50.0	50.0	1023644	409406	20473	8188	39.919	25.245	47.232
100 X 50 - 1.2 mm	1.2	18	100	50	15	4.05	517.41	50.0	50.0	830564	332577	16611	6652	40.065	25.353	47.413
120 X 60 - 3.0 mm	3.0	11	120	60	15	12.25	1481.00	60.0	60.0	3343088	1239790	55718	20663	47.511	28.933	55.628
120 X 60 - 2.5 mm	2.5	12	120	60	15	10.21	1246.30	60.0	60.0	2842677	1056667	47378	17611	47.759	29.118	55.935
120 X 60 - 2.0 mm	2.0	14	120	60	15	8.16	1006.80	60.0	60.0	2320140	864481	38669	14408	48.005	29.303	56.242
120 X 60 - 1.5 mm	1.5	16	120	60	15	6.12	762.38	60.0	60.0	1775043	662978	29584	11050	48.252	29.489	56.550
120 X 60 - 1.2 mm	1.2	18	120	60	15	4.90	613.41	60.0	60.0	1436975	537498	23950	8958	48.400	29.601	56.735
150 X 50 - 3.0 mm	3.0	11	150	50	17	12.62	1565.00	50.0	75.0	5073825	815351	67651	16307	56.939	22.825	61.344
150 X 50 - 2.5 mm	2.5	12	150	50	17	10.52	1316.30	50.0	75.0	4309274	696256	57457	13925	57.217	22.999	61.666
150 X 50 - 2.0 mm	2.0	14	150	50	17	8.42	1062.80	50.0	75.0	3512990	570760	46840	11415	57.493	23.174	61.987
150 X 50 - 1.5 mm	1.5	16	150	50	17	6.31	804.38	50.0	75.0	2684448	438628	35793	8773	57.769	23.352	62.310
150 X 50 - 1.2 mm	1.2	18	150	50	17	5.05	647.01	50.0	75.0	2171621	356064	28955	7121	57.934	23.459	62.504
160 X 60 - 3.0 mm	3.0	11	160	60	20	14.32	1781.00	60.0	80.0	6800416	1445889	85005	24098	61.793	28.493	68.045
160 X 60 - 2.5 mm	2.5	12	160	60	20	11.93	1496.30	60.0	80.0	5762299	1229688	72029	20495	62.057	28.667	68.358
160 X 60 - 2.0 mm	2.0	14	160	60	20	9.55	1206.80	60.0	80.0	4686828	1003947	58585	16732	62.319	28.843	68.670
160 X 60 - 1.5 mm	1.5	16	160	60	20	7.16	912.38	60.0	80.0	3573431	768390	44668	12807	62.583	29.020	68.984
160 X 60 - 1.2 mm	1.2	18	160	60	20	5.73	733.41	60.0	80.0	2886954	622228	36087	10370	62.740	29.127	69.172
220 X 80 - 3.0 mm	3.0	11	220	80	20	19.12	2381.00	80.0	110.0	17380746	3096583	158007	38707	85.439	36.063	92.738
220 X 80 - 2.5 mm	2.5	12	220	80	20	15.94	1996.30	80.0	110.0	14666047	2623250	133328	32791	85.712	36.250	93.063
220 X 80 - 2.0 mm	2.0	14	220	80	20	12.75	1606.80	80.0	110.0	11879564	2133312	107996	26666	85.984	36.437	93.386
220 X 80 - 1.5 mm	1.5	16	220	80	20	9.56	1212.40	80.0	110.0	9020504	1626395	82005	20330	86.257	36.626	93.711
220 X 80 - 1.2 mm	1.2	18	220	80	20	7.65	973.41	80.0	110.0	7269906	1313939	66090	16424	86.420	36.740	93.906
305 X 80 - 3.0 mm	3.0	11	305	80	25	23.46	2951.00	80.0	152.5	38778916	3467894	254288	43349	114.634	34.281	119.650
305 X 80 - 2.5 mm	2.5	12	305	80	25	19.55	2471.30	80.0	152.5	32647188	2934243	214080	36678	114.937	34.458	119.991
305 X 80 - 2.0 mm	2.0	14	305	80	25	15.64	1986.80	80.0	152.5	26384306	2383417	173012	29793	115.238	34.636	120.330
305 X 80 - 1.5 mm	1.5	16	305	80	25	11.73	1497.40	80.0	152.5	19989218	1815009	131077	22688	115.539	34.815	120.671
355 X 110 - 3.0 mm	3.0	11	355	110	25	28.50	3611.00	110.0	177.5	67109176	8035608	378080	73051	136.326	47.173	144.257
355 X 110 - 2.5 mm	2.5	12	355	110	25	23.75	3021.30	110.0	177.5	56390424	6777680	317693	61615	136.617	47.363	144.595
355 X 110 - 2.0 mm	2.0	14	355	110	25	19.00	2426.80	110.0	177.5	45486912	5487950	256264	49890	136.907	47.554	144.931

5

5.8 PERFIL ESTRUCTURAL I GALVANIZADO

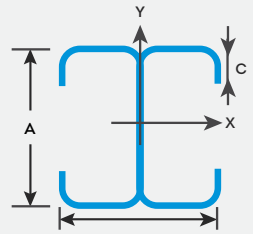

PROPIEDADES MECÁNICAS DE LA SECCIÓN COMPLETA - PERFIL ESTRUCTURAL I GALVANIZADO

REFERENCIA PERFIL	ESPESOR (mm)	CALIBRE #	A (mm)	B (mm)	C (mm)	PESO (kgf/m)	ÁREA (mm ²)	X CENT (mm)	Y CENT (mm)	MOMENTO DE INERCIA		MÓDULO DE SECCIÓN		RADIO DE GIRO		
										Ix (mm ⁴)	Iy (mm ⁴)	Sx (mm ³)	Sy (mm ³)	rx (mm)	ry (mm)	ro (mm)
100 X 50 - 1.9 mm	1.9	14	100	50	15	6.39	794.12	50.0	50.0	1253984	500817	25080	10016	39.738	25.113	47.008
100 X 50 - 1.5 mm	1.5	16	100	50	15	5.01	625.82	50.0	50.0	998230	399304	19965	7986	39.938	25.260	47.256
100 X 50 - 1.2 mm	1.2	18	100	50	15	3.99	500.61	50.0	50.0	804387	322147	16088	6443	40.085	25.367	47.438
120 X 60 - 1.9 mm	1.9	14	120	60	15	7.73	943.72	60.0	60.0	2180602	812996	36343	13550	48.069	29.351	56.322
120 X 60 - 1.5 mm	1.5	16	120	60	15	6.05	742.62	60.0	60.0	1730448	646448	28841	10774	48.272	29.504	56.575
120 X 60 - 1.2 mm	1.2	18	120	60	15	4.83	593.41	60.0	60.0	1391269	520505	23188	8675	48.420	29.617	56.760
150 X 50 - 1.9 mm	1.9	14	150	50	17	7.96	996.08	50.0	75.0	3300693	537053	44009	10741	57.565	23.220	62.071
150 X 50 - 1.5 mm	1.5	16	150	50	17	6.24	783.50	50.0	75.0	2616756	427763	34890	8555	57.791	23.366	62.336
150 X 50 - 1.2 mm	1.2	18	150	50	17	4.98	625.89	50.0	75.0	2102347	344865	28031	6897	57.957	23.473	62.530
160 X 60 - 1.9 mm	1.9	14	160	60	20	9.03	1130.70	60.0	80.0	4401014	943658	55013	15728	62.388	28.889	68.752
160 X 60 - 1.5 mm	1.5	16	160	60	20	7.08	888.62	60.0	80.0	3482703	749113	43534	12485	62.604	29.035	69.009
160 X 60 - 1.2 mm	1.2	18	160	60	20	5.65	709.41	60.0	80.0	2794370	602462	34930	10041	62.761	29.142	69.197
220 X 80 - 1.9 mm	1.9	14	220	80	20	12.07	1504.70	80.0	110.0	11143222	2003161	101302	25040	86.056	36.487	93.471
220 X 80 - 1.5 mm	1.5	16	220	80	20	9.45	1180.60	80.0	110.0	8788620	1585097	79897	19814	86.280	36.642	93.738
220 X 80 - 1.2 mm	1.2	18	220	80	20	7.54	941.41	80.0	110.0	7034488	1271802	63950	15898	86.442	36.755	93.932
305 X 80 - 1.9 mm	1.9	14	305	80	25	14.80	1860.00	80.0	152.5	24734358	2237342	162193	27967	115.317	34.682	120.420
305 X 80 - 1.5 mm	1.5	16	305	80	25	11.59	1458.00	80.0	152.5	19471872	1768763	127684	22110	115.565	34.830	120.699
355 X 110 - 1.9 mm	1.9	14	355	110	25	17.98	2271.40	110.0	177.5	42621584	5147342	240122	46794	136.983	47.604	145.019

5

5.9 CUBIERTA TRAPEZOIDAL

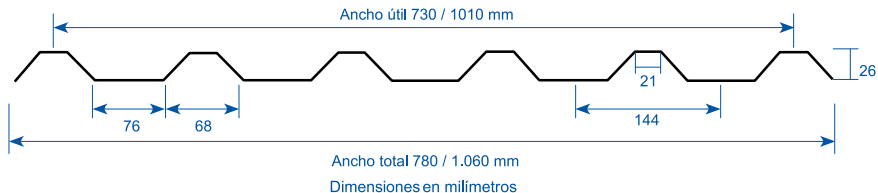

FICHA TÉCNICA

GALVANIZADO	LONG. (mm)	PESO (Kgf/und)	PINTADA 0.30 mm	LONG (mm)	PESO (Kgf/und)
0.73 x 1.83 (0.30mm)	1830	3.85	1.01 x 1.83 (0.30mm)	1830	5.13
0.73 x 2.44 (0.30mm)	2440	5.13	1.01 x 2.44 (0.30mm)	2440	6.85
0.73 x 3.05 (0.30mm)	3050	6.41	1.01 x 3.05 (0.30mm)	3050	8.56
0.73 x 3.66 (0.30mm)	3660	7.69	1.01 x 3.66 (0.30mm)	3660	10.27

ESPECIFICACIONES

ESPESOR	CALIBRE	ACABADO	PESO (Kgf/m ²)	ANCHO ÚTIL (mm)	ANCHO ÚTIL (mm)
0.30 mm	30	Galvanizado	2.88	730	780
0.30 mm	30	Pintado	2.78	1010	1060
0.36 mm	28	Galvanizado	3.35	1010	1060
0.46 mm	26	Galvanizado y/o pintado	4.29	1010	1060
0.60 mm	24	Galvanizado y/o pintado	5.62	1010	1060
0.70 mm	22	Galvanizado	6.57	1010	1060

TABLA DE CARGA

LUCES (mm)	LUZ SIMPLE CARGA (Kgf/m ²)					LUZ CONTINUA CARGA (Kgf/m ²)				
	CAL 30	CAL 28	CAL 26	CAL 24	CAL 22	CAL 30	CAL 28	CAL 26	CAL 24	CAL 22
1500	45	58	81	111	131	79	98	138	203	246
1700	31	40	56	76	90	55	68	95	139	175
1900	22	29	40	54	64	39	48	68	100	125
2100						29	36	50	74	93
2300						22	27	38	56	71

Nota:

- Tornillos fijadores de ala a 800 mm cada uno.
- Distancia recomendada entre correas: 1700 mm.
- Acabado: Galvanizado ó Galvalume* pintado.
- Para cubiertas pintadas, verificar disponibilidad de calibres y colores.
- También disponible en calibres 28, 26, 24 y 22 en longitudes especiales, de acuerdo con el despiece del proyecto.

- Altura cresta: 26 mm.
- Pendiente mínima con traslazo: 15%.
- Pendiente mínima sin traslazo: 6%.
- Traslazo longitudinal mínimo: 150 mm.
- Voladizo máximo: 300 mm.

* Galvalume: recubrimiento de acero compuesto por: 55% Aluminio y 45% de Zinc.

5

5.10 CUBIERTA TRAPEZOIDAL TIPO CANALETA

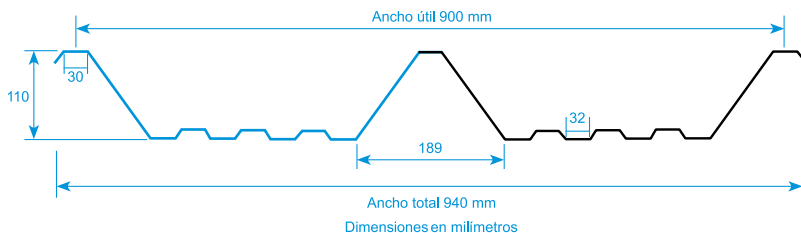

FICHA TÉCNICA

GALVANIZADA	LONG. (mm)	PESO (Kgf/und)
0.90 x 3.00-26 (0.46mm)	3000	13.01
0.90 x 4.50-24 (0.60mm)	4500	25.55
0.90 x 5.00-24 (0.60mm)	5000	28.39
0.90 x 6.00-24 (0.60mm)	6000	34.07
0.90 x 7.00-24 (0.60mm)	7000	39.75
0.90 x 8.00-24 (0.60mm)	8000	45.43

ESPECIFICACIONES

ESPESOR	CALIBRE	ACABADO	PESO (Kgf/m ²)	ANCHO ÚTIL (mm)	VOLADIZO MÁXIMO (mm)
0.46 mm	26	Galvanizado y/o pintado	4.95	900	600
0.60 mm	24	Galvanizado y/o pintado	6.44	900	800
0.70 mm	22	Galvanizado	7.50	900	800

TABLA DE CARGA

LUCES (mm)	LUZ SIMPLE CARGA (Kgf/m ²)			LUZ CONTINUA CARGA (Kgf/m ²)		
	CAL 26	CAL 24	CAL 22	CAL 26	CAL 24	CAL 22
4600	40	63	81	74	120	144
4800	35	55	71	68	110	132
5000	31	49	63	63	102	122
5200	28	43	56	58	94	113
5400	25	39	50	54	87	104
5600	22	35	45	50	81	97
5800	20	31	40	47	75	91
6000	18	28	36	44	68	85



Nota:

- Tornillos fijadores de ala a 1500 mm cada uno.
- Distancia recomendada entre correas: 5000 mm.
- Acabado: Galvanizado ó Galvalume* pintado.
- También disponible en longitudes especiales, de acuerdo con el despiece del proyecto.

- Altura cresta: 110 mm.
- Voladizo máximo: 600 mm (Cal 26).
- Pendiente mínima con traslazo: 15%.
- Pendiente mínima sin traslazo: 6%.
- Traslazo longitudinal mínimo: 150 mm.

* Galvalume: recubrimiento de acero compuesto por: 55% Aluminio y 45% de Zinc.

5

5.11 CUBIERTA METÁLICA

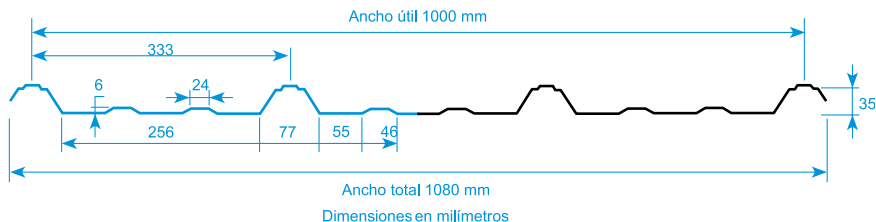

FICHA TÉCNICA		
GALVANIZADA	LONG. (mm)	PESO (Kgf/und)
1.00 x 1.83 (0.36mm)	1830	6.19
1.00 x 2.14 (0.36mm)	2140	7.23
1.00 x 2.44 (0.36mm)	2440	8.25
1.00 x 3.05 (0.36mm)	3050	10.31
1.00 x 3.66 (0.36mm)	3660	12.37

ESPECIFICACIONES					
ESPESOR	CALIBRE	ACABADO	PESO (Kgf/m ²)	ANCHO ÚTIL (mm)	ANCHO TOTAL (mm)
0.36 mm	28	Galvanizado	3.38	1000	1080
0.46 mm	26	Galvanizado	4.34	1000	1080
0.60 mm	24	Galvanizado	5.68	1000	1080

TABLA DE CARGA						
LUCES (mm)	LUZ SIMPLE CARGA (Kgf/m ²)			LUZ CONTINUA CARGA (Kgf/m ²)		
	CAL 28	CAL 26	CAL 24	CAL 28	CAL 26	CAL 24
1000	180	262	359	197	262	354
1100	148	217	297	163	216	293
1200	125	182	249	137	182	246
1300	106	155	213	116	155	210
1400	92	134	183	100	134	181
1500	80	116	160	87	116	158
1600	70	102	140	77	102	138
1700	62	91	124	68	91	123
1800	55	81	111	61	81	109
1900	50	73	99	55	73	98
2000	45	66	90	49	65	89

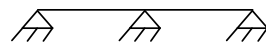
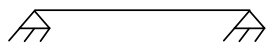

Nota:

- Tornillos fijadores de de ala a 1000 mm cada uno.
- Distancia recomendada entre correas: 1900 mm.
- Acabado: Galvanizado.
- También disponible en calibre 26 y 24. En longitudes especiales de acuerdo con el despiece del proyecto.

- Altura cresta: 35 mm.
- Voladizo máximo: 400 mm.
- Pendiente mínima con traslapo: 15%.
- Pendiente mínima sin traslapo: 6%.
- Traslapo longitudinal mínimo: 150 mm.

5

5.12 TEJA SIN TRASLAPO

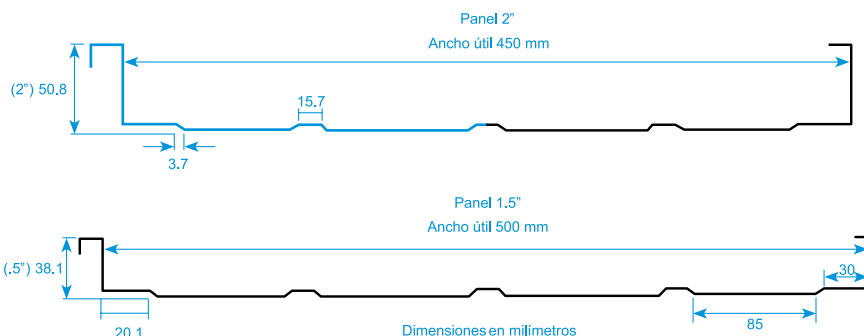

FICHA TÉCNICA

ALTURA PANEL	ESPESOR (mm)	CALIBRE	PESO Kg/m ²	ANCHO ÚTIL (mm)
2" (50.8 mm)	0.60	24	6.31	450
	0.46	26	4.82	
1 1/2" (38.1 mm)	0.60	24	5.68	500
	0.46	26	4.34	

TABLA DE CARGA PANEL 2"

LUCES (mm)	LUZ SIMPLE CARGA (Kgf/m ²)		LUZ CONTINUA CARGA (Kgf/m ²)	
	CAL 26	CAL 24	CAL 26	CAL 24
1800	78	123	110	181
1900	67	104	99	163
2000	57	89	89	147
2100	49	77	81	133
2200	43	67	74	121



TABLA DE CARGA PANEL 1 1/2"

LUCES (mm)	LUZ SIMPLE CARGA (Kgf/m ²)		LUZ CONTINUA CARGA (Kgf/m ²)	
	CAL 26	CAL 24	CAL 26	CAL 24
1400	49	101	115	174
1500	40	82	97	152
1600	33	68	80	134
1700	28	56	66	118
1800	23	48	56	106

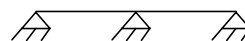
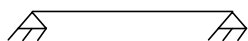
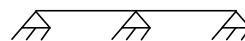

5

5.12 TEJA SIN TRASLAPO

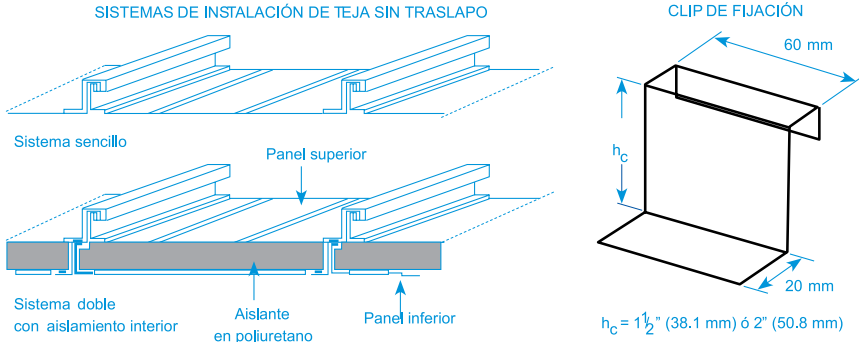





FICHA TÉCNICA		
RADIO MÍNIMO DE CURVATURA	ALTURA DEL PANEL	CALIBRES DE FORMACIÓN
1.5 mm	1 1/2"	24 y 26



Nota:

- Distancia máxima recomendada entre correas: 1700 mm.
- Pendiente mínimo del panel: 4%.
- Acabado: Galvanizado ó Galvalume* pintado.
- Disponible en longitudes especiales de acuerdo con el despiece del proyecto.

5

5.13 RESUMEN

RESUMEN DE PERLINES MAS COMERCIALES												
Rango (Altura)	PHR C			PAG C			PHR Z			PAG Z		
Milímetros (Pulg.)												
	ALTURA	ALA	ESPESOR	ALTURA	ALA	ESPESOR	ALTURA	ALA	ESPESOR	ALTURA	ALA	ESPESOR
	MM	MM	MM	MM	MM	MM	MM	MM	MM	MM	MM	MM
50<h<101.6 (4")	100	50	1.2	100	50	1.2						
	100	50	1.5	100	50	1.5						
	100	50	2.0	100	50	1.9						
	100	50	2.5									
102<h<127 (5")	120	60	1.2	120	60	1.2						
	120	60	1.5	120	60	1.5						
	120	60	2.0	120	60	1.9						
	120	60	2.5									
128<h<152.4 (6")	150	50	1.2	150	50	1.2						
	150	50	1.5	150	50	1.5						
	150	50	2.0	150	50	2.0						
	150	50	2.5									
153<h<177.8 (7")	160	60	1.2	160	60	1.2	160	60	1.2	160	60	1.2
	160	60	1.5	160	60	1.5	160	60	1.5	160	60	1.5
	160	60	2.0	160	60	1.9	160	60	2.0	160	60	1.9
	160	60	2.5				160	60	2.5			
178<h<228.6 (9")	220	80	1.2	220	80	1.2	220	80	1.2	220	80	1.2
	220	80	1.5	220	80	1.5	220	80	1.5	220	80	1.5
	220	80	2.0	220	80	1.9	220	80	2.0	220	80	1.9
	220	80	2.5				220	80	2.5			
229<h<305 (12")	305	80	1.5	305	80	1.5	305	80	1.5	305	80	1.5
	305	80	2.0	305	80	1.9	305	80	2.0	305	80	1.9
	305	80	2.5				305	80	2.5			
	305	80	3.0				305	80	3.0			
306<h<355.6 (14")	355	110	2.0	355	110	1.9						
	355	110	2.5									
	355	110	3.0									
TOTALES	31			18			14			8		
GENERAL	71											

-  Los productos sombreados SON de nuestra comercialización habitual.
-  Otros productos venta solo bajo pedido, sujeto a entrega del productor.

Nota: Para identificar que productos debían hacer parte del presente resumen, nuestra empresa realizó un análisis basados en su experiencia en el sector. Es posible que en el mercado existan otros elementos de acero de uso estructural que también son comerciales en Colombia pero que no están incluidos en este resumen.

5

5.13 RESUMEN

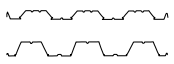
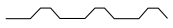
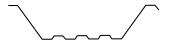
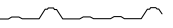
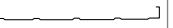
RESUMEN DE LOSAS Y CUBIERTAS MAS COMERCIALES															
Rango (Espesor)	STEEL DECK			CUBIERTA ARO.			CANALETA			MASTER 1000			TEJA SIN TRAS.		
Milímetros (Cal.)															
	ALTURA	ANCHO	ESPESOR	ANCHO	LONG.	ESPESOR	ANCHO	LONG.	ESPE-SOR	ANCHO	LONG.	ESPESOR	ALTURA	ANCHO	ESPE-SOR
	MM	MM	MM	MTS	MTS	MM	MTS	MTS	MM	MTS	MTS	MM	MM	MM	MM
0.25<e<=0.27 (Cal. 31)															
0.28<e<=0.3 (Cal. 30)				TZA 0.73	1.83	0.30									
				TZA 0.73	2.44	0.30									
				TZA 0.73	3.05	0.30									
				TZA 0.73	3.66	0.30									
0.31<e<=0.36 (Cal. 28)												TZC 1.00	1.83	0.36	
												TZC 1.00	2.14	0.36	
												TZC 1.00	2.44	0.36	
												TZC 1.00	3.05	0.36	
0.37<e<=0.46 (Cal. 26)															
0.47<e<=0.6 (Cal. 24)															
0.61<e<=0.75 (Cal. 22)															
0.71<e<=0.9 (Cal. 20)															
0.91<e<=1.2 (Cal. 18)															
1.21<e<=1.5 (Cal. 16)															
TOTALES															
GENERAL															

- Los productos sombreados SON de nuestra comercialización habitual.
- Otros productos venta solo bajo pedido, sujeto a entrega del productor.

Nota: Para identificar que productos debían hacer parte del presente resumen, nuestra empresa realizó un análisis basados en su experiencia en el sector. Es posible que en el mercado existan otros elementos de acero de uso estructural que también son comerciales en Colombia pero que no están incluidos en este resumen.



STECKERLACEROS

TRIPLE-S STEEL

BOGOTÁ

Cra 128 No. 14B-31 PBX: (1) 744 6262
bogota@steckerlaceros.com

BARRANQUILLA

Carretera La Cordialidad Km. 114 a 3 Km.
de la Circunvalar de Barranquilla
PBX: (5) 385 0707 • Fax: Ext 171
barranquilla@steckerlaceros.com

MEDELLÍN

Cra 43a No. 19 - 17
Ed. Block - Of. 228 PBX: (4) 604 8777
medellin@steckerlaceros.com

CARTAGENA

Carretera El Bosque, frente a la salida
a Mamonal Trasnv. 54 Dg 30 esquina
PBX: (5) 693 0303
cartagena@steckerlaceros.com

BUARAMANGA

Calle 24 No 10-30 PBX: (7) 697 0606
bucaramanga@steckerlaceros.com

CALI

Calle 34 No. 7 - 159 - Barrio El Troncal
PBX: (2) 485 1999 cali@steckerlaceros.com

EJE CAFETERO

Cel: 320 584 6188

NEIVA / IBAGUÉ

Cel: 320 584 6208

✉ servicioalcliente@steckerlaceros.com

www.steckerlaceros.com